

GLASROC X SHEATHING BOARD

Installation Guide



Glasroc X Sheathing Board Installation Guide

Contents



- 3** Introduction
- 4** General Guidance
- 6** Glasroc X Sealing Tape White Guidance
- 9** Glasroc X Sealant Guidance
- 11** Breather Membrane Guidance
- 13** Exposed Edges and Window Openings Guidance
- 14** Health and Safety
- 15** Components

Glasroc X Sheathing Board Installation Guide

Introduction

Glasroc X Sheathing Board is a high performance sheathing board which provides up to 6 months weather protection as certified by the British Board of Agreement (BBA). It is a reliable lightweight alternative to cement particle boards, without the need for specialist cutting or dust extraction when cutting on site, making it faster to install and creating less mess.



This is the only gypsum based sheathing board with full BBA certification verifying its weather protection performance in its own right, rather than as part of a system. This means that you can be confident that the board will withstand all typical UK weather conditions prior to the completion of the external facade.

The board has a gypsum core containing special additives for moisture and mould resistance, is reinforced with a glass mat on both surfaces and is finished with a UV resistant coating. The non-paper faced board is free from cellulose content and therefore has a strong resistance to mould growth and water penetration, whilst also providing Euroclass A1 non-combustible reaction to fire performance.

The board is BES6001 certified 'Good' which means that it can contribute to points and credits under environmental schemes such as BREEAM.

Benefits of Glasroc X Sheathing Board

- Easy to score and snap resulting in valuable programme time savings compared to cement particle boards
- Lightweight, a maximum of 11.8 kg/m² for easier site movement and installation. Compared to cement particle boards this equates to a weight reduction of approximately 35%, resulting in a product that is easier to handle and install, especially when working at height
- Tested systems for up to 120 minutes fire resistance are available
- If installed correctly can provide sufficient weather-proofing, potentially eliminating the need for a breather membrane



Glasroc X Sheathing Board Installation Guide

General Guidance



Before boarding it is recommended to assess and pre-plan board fixing layout to avoid vertical joints falling on jamb studs.

Boards can be installed in either a horizontal or vertical orientation. It is recommended that Glasroc X Sheathing Boards are installed in dry conditions.

If using Glasroc X Sealant, joints must be sealed as boarding progresses (see page 9).

If using Glasroc X Sealing Tape White, taping is completed after board installation (see page 6).

Glasroc X Sheathing Boards may be cut using a plasterboard saw or by scoring through the surface glass mat with a board knife.

The core is snapped over a straight edge and the boards turned over and cut through the back face glass mat.

Glasroc X Sheathing Boards are fixed securely to Steel Framing System (SFS) framing supports around the perimeter of the board and intermediate stud positions at maximum 300 mm centres except the head channel. Uppermost board fixing to be determined depending on deflection head required. External corners reduce fixings to 200 mm. Stagger horizontal and vertical joints between layers by at least 600 mm.

First fixing of the board into the stud should be 100 mm above the floor channel leg and then fixed working up the stud. The boards should be fixed with a 6mm gap away from masonry or similar materials, to prevent moisture absorption. The lowest point of the boards must be kept above damp-proof course level. Position screws not less than 15mm from edges. Set screw heads flush with Glasroc X Sheathing Board surface; do not break gypsum core.

Glasroc X Sheathing Board Installation Guide

General Guidance



Joints between Glasroc X Sheathing Boards must be sealed either using Glasroc X Sealant (5a) (as boarding progresses) or Glasroc X Sealing Tape White (5b). For detailed installation, see page 6 for Glasroc X Sealing Tape White and page 9 for Glasroc X Sealant.



Screws

Glasroc X screws are suitable for fixing Glasroc X Sheathing Boards into structural steel frame studs up to 2.5 mm gauge steel and minimum 1.2 mm.

Ensure a minimum screw penetration of 10mm into metal framing through the board.

Glasroc X screw heads must sit flush to the board to ensure optimum weather protection.

Steel Framing System

Items such as façade brackets, cladding rails and other heavy items can not be fixed only to Glasroc X Sheathing Boards, always fix into studs. Accessories such as horizontal cladding top hats (by others) can be utilised to avoid board-only fixing.

Finishing/Rendering

Glasroc X Sheathing Board can be rendered in the BBA certified Weber weberend MT system.

Glasroc X Sheathing Board Installation Guide

Glasroc X Sealing Tape White Guidance

Installation of Glasroc X Sealing Tape White on board joints:

Follow this installation process (external face application only) to ensure weather-proofing whilst Glasroc X Sheathing Board is exposed. The tape should be installed in temperatures between -10 °C to +45 °C. Boards should be sufficiently clean and dry.

- Working upwards from the bottom apply Glasroc X Sealing Tape White centrally to the vertical joints up to the lowest horizontal joint. Apply sufficient pressure to ensure good adhesion.
- Apply Glasroc X Sealing Tape White centrally to the horizontal joint, overlapping the vertical joint tape by a minimum of 15 mm.
- Tape the next vertical joint above, overlapping the horizontal joint tape by a minimum of 25 mm.
- When splicing tape, there must be an overlap of approx. 50 mm.

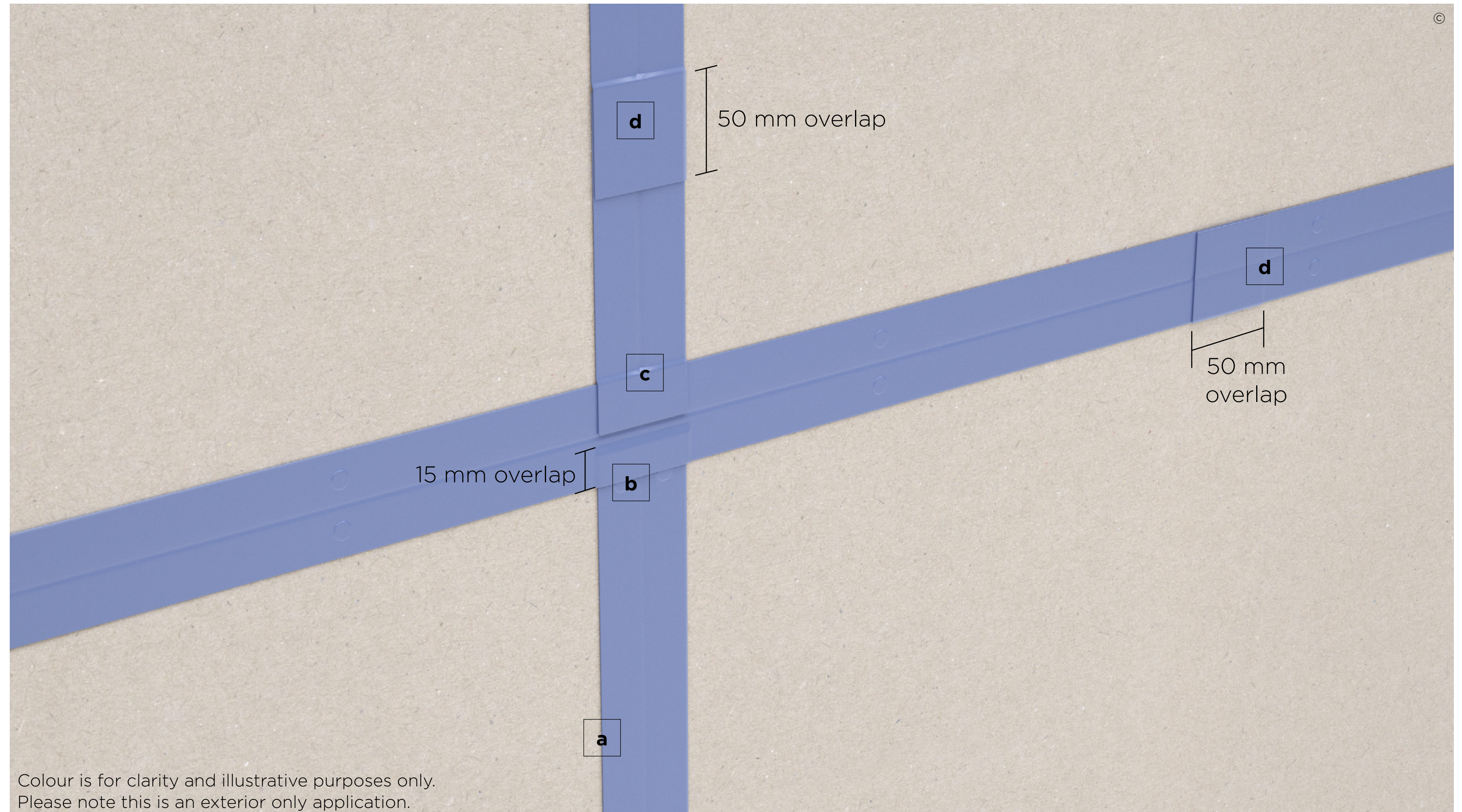

Glasroc X Sheathing Board Installation Guide

Glasroc X Sealing Tape White Guidance

Installation of Glasroc X Sealing Tape White on exposed edges and window openings

Follow this installation process to ensure weather-proofing whilst Glasroc X Sheathing Board is exposed.

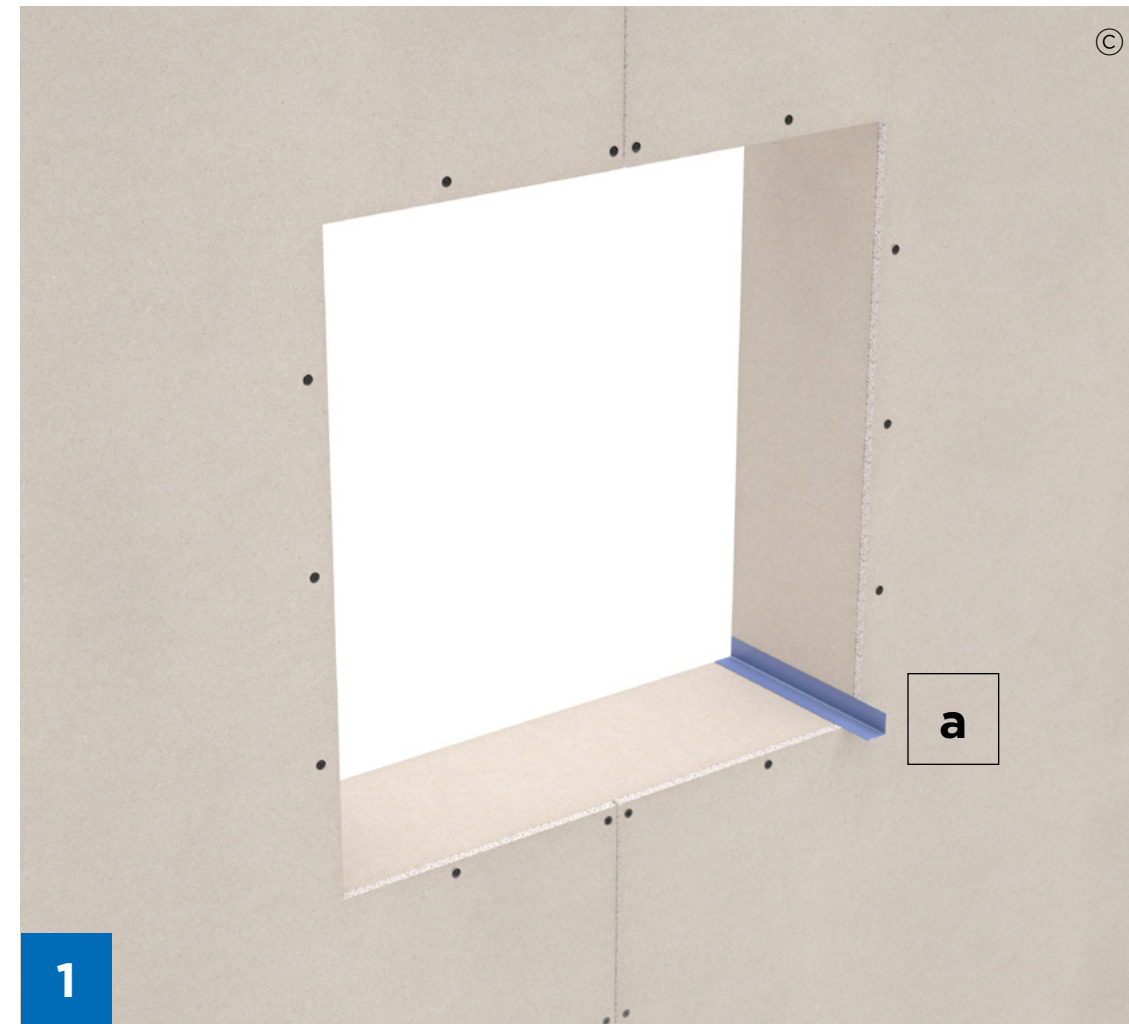

Cut suitably long pieces of Glasroc X Sealing Tape White and attach them to the corners of the window opening (a). Each piece of tape must protrude 30-50 mm from the window opening.

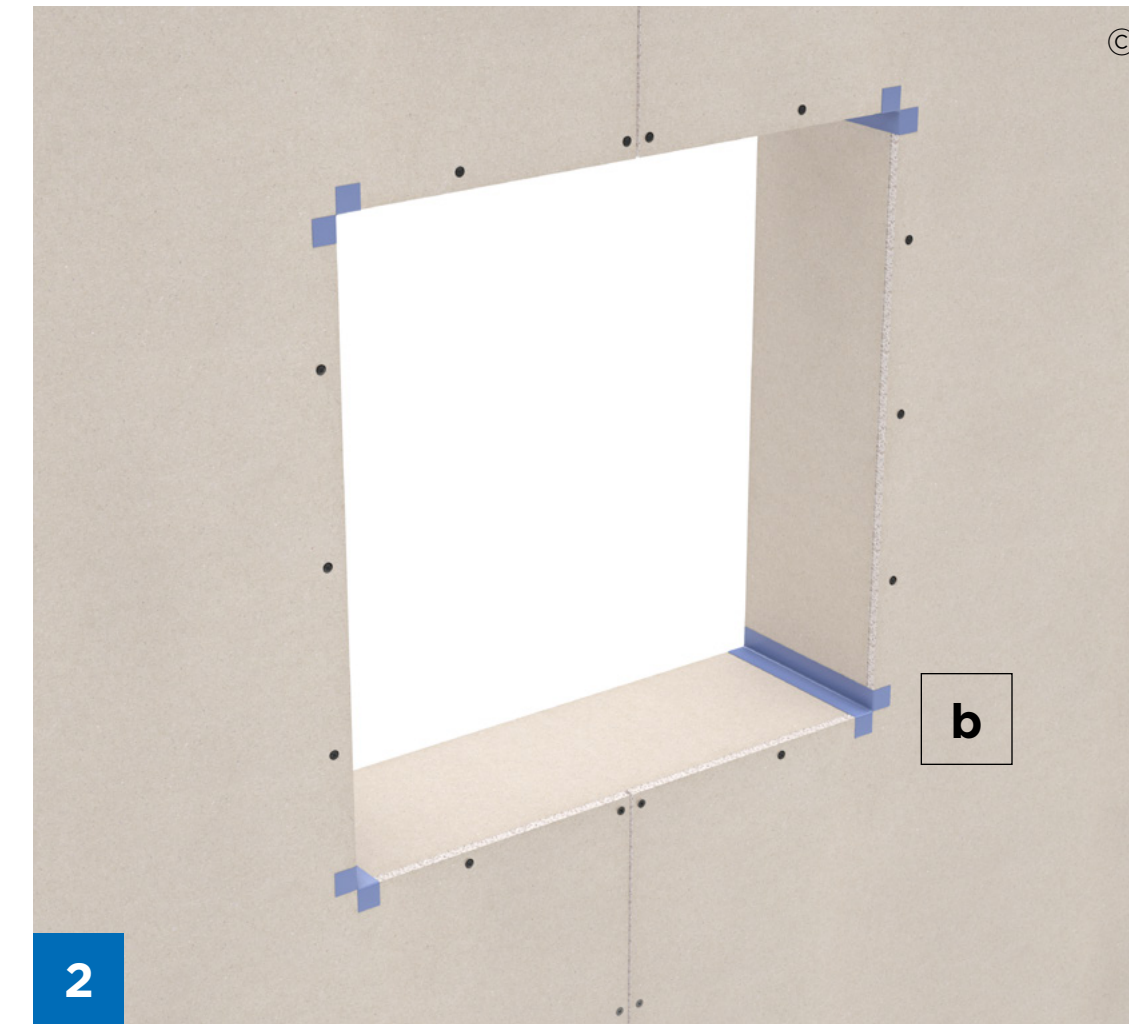

Cut the protruding ends of Glasroc X Sealing Tape White along the fold and press the ends to each side, against the board (b). Repeat this for all four corners.

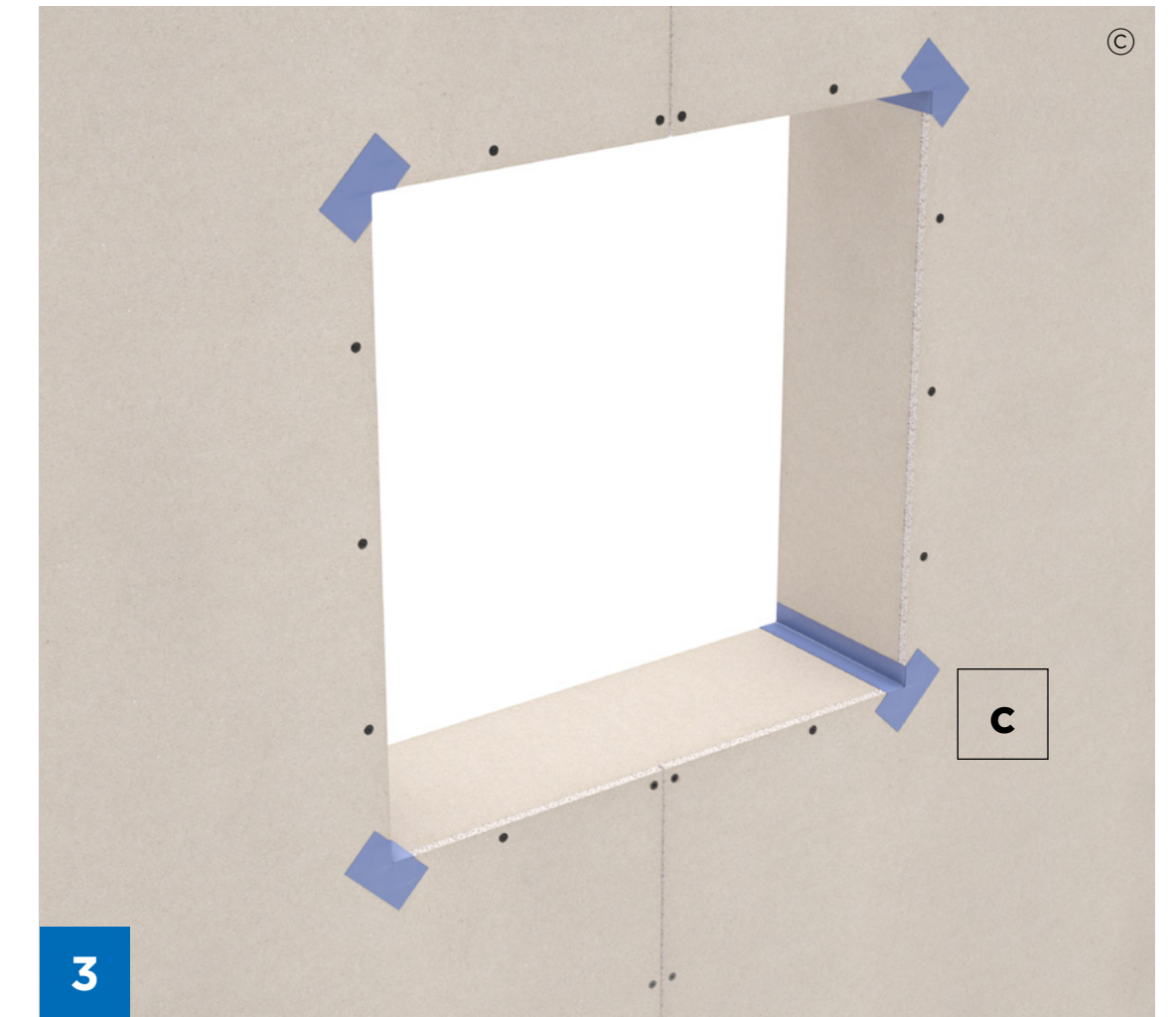

Apply a piece of Glasroc X Sealing Tape White diagonally across each corner joint (c) with the centre over the corner. Cut as shown in the illustration and press the ends firmly against the surface of the board. Repeat this for all four corners.

Glasroc X Sheathing Board Installation Guide

Glasroc X Sealing Tape White Guidance

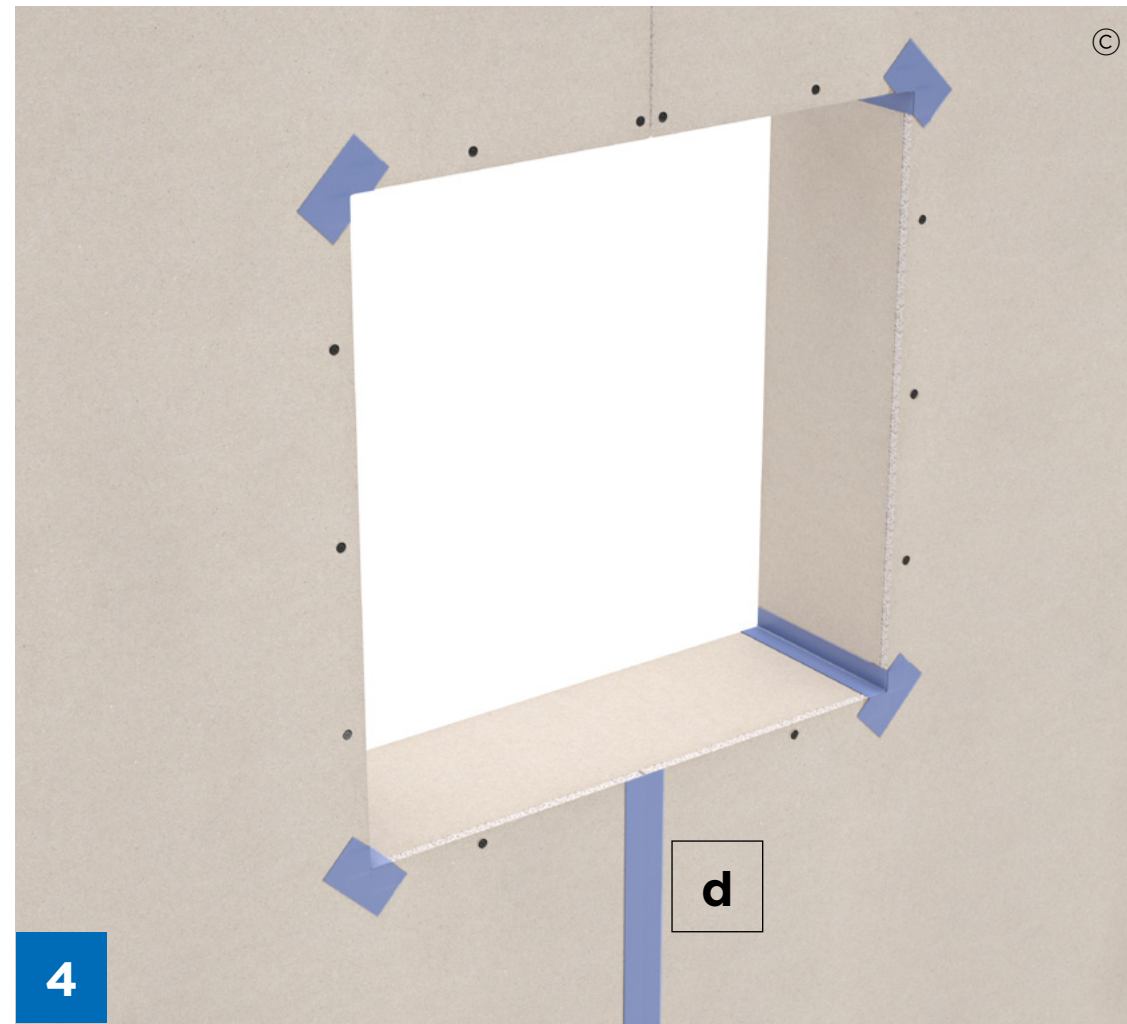

Then, tape any vertical joints under the window opening (d).

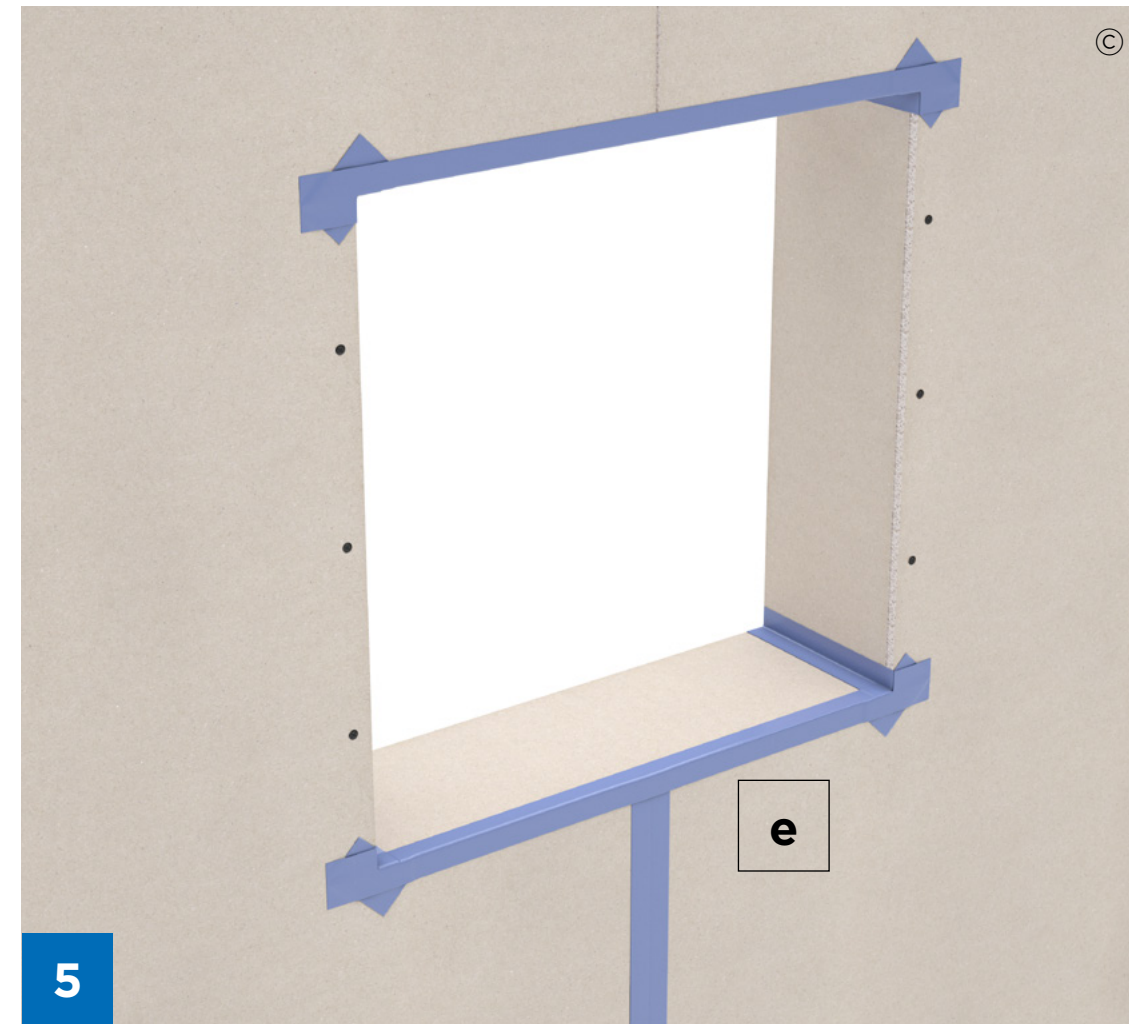

Cut two pieces of tape 100 mm (50 mm each end) wider than the opening and apply them centrally to the upper and lower edges of the window opening (e). Cut as shown in the illustration and press the tape sides firmly against the surfaces.

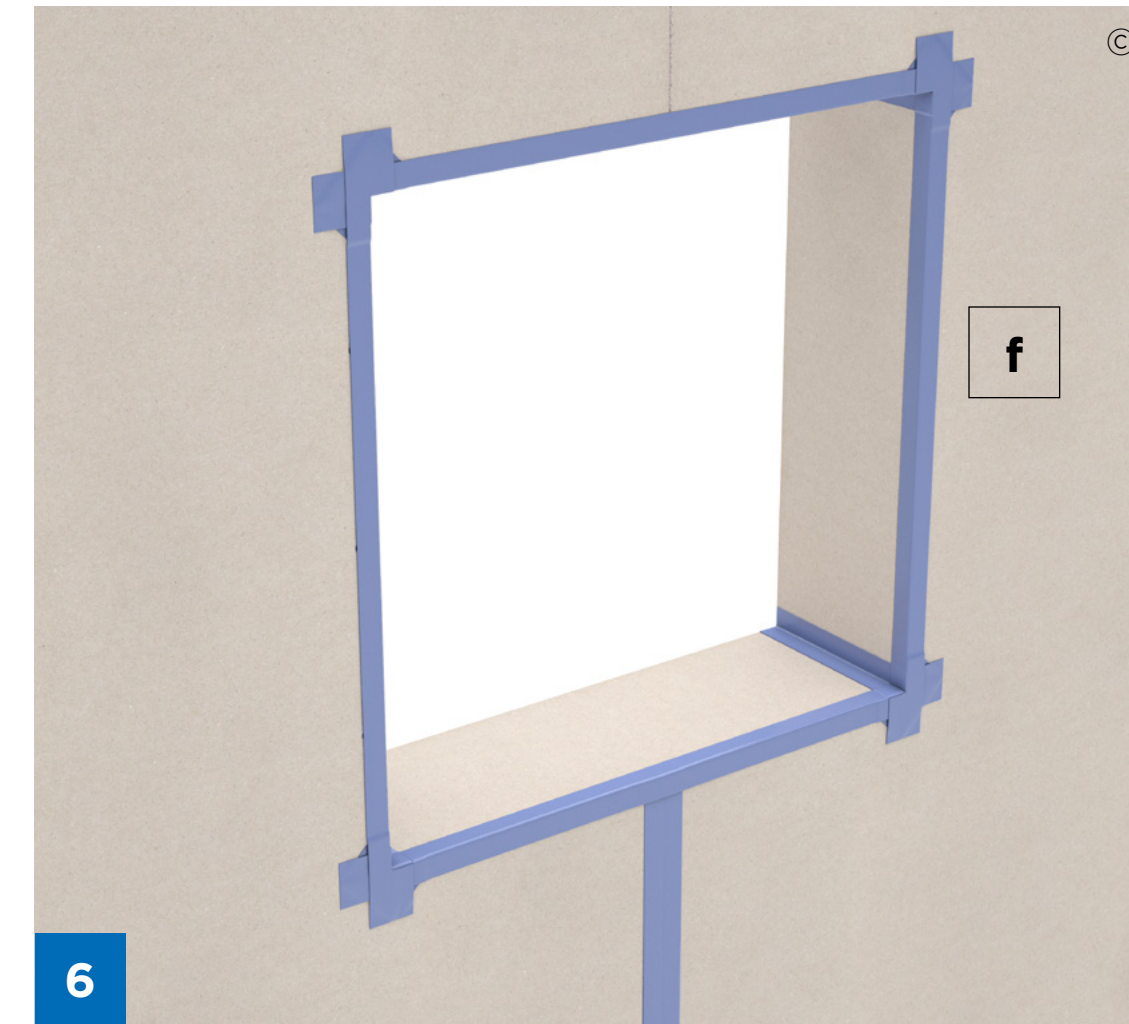

Cut two pieces of tape 100 mm (50 mm each end) longer than the opening and apply them centrally to the vertical edges of the window opening (f). Cut as shown in the illustration and press the tape sides firmly against the surface.

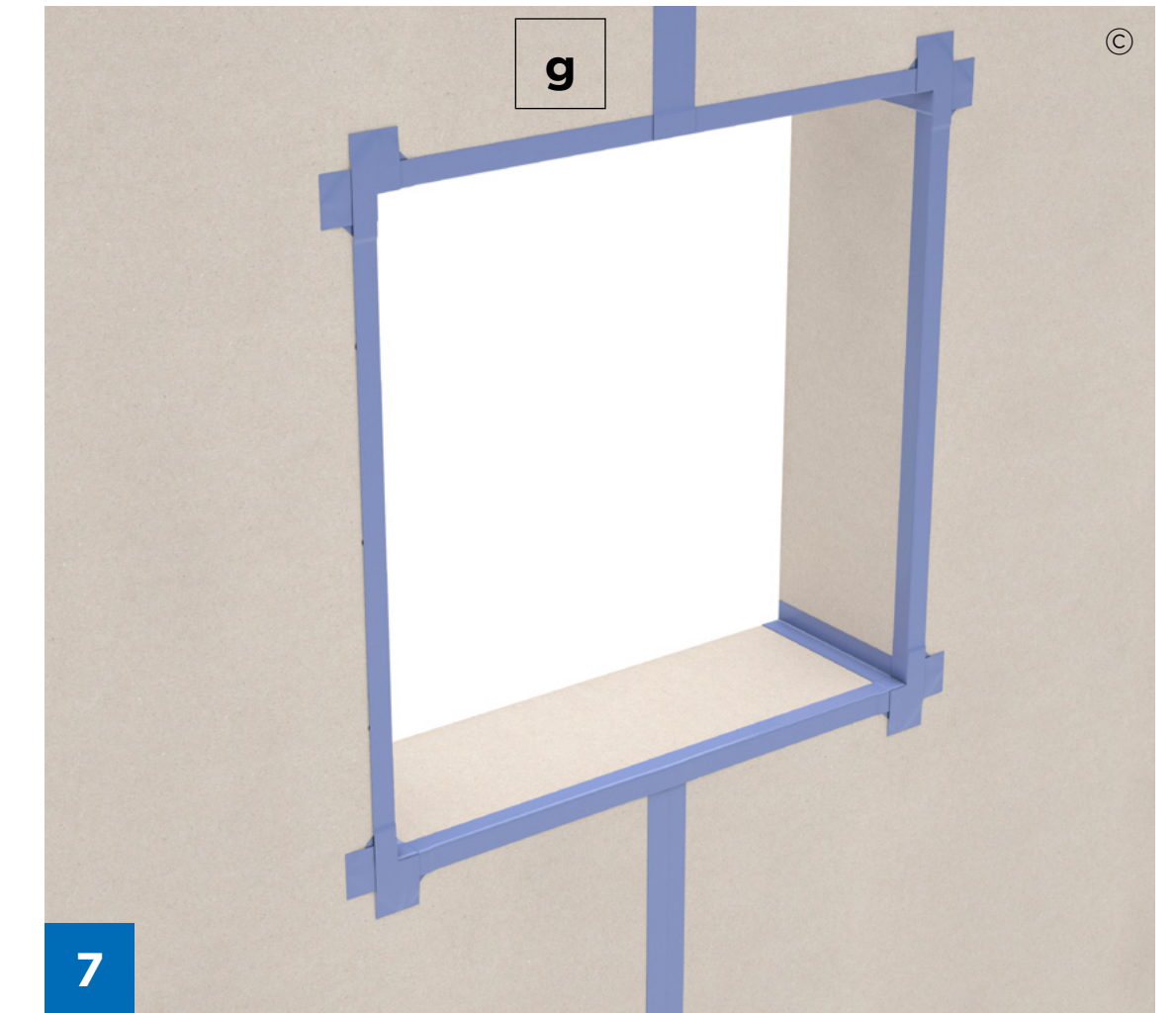

Then, tape any vertical joints above the window opening (g).

General Tape Guidance

Glasroc X Sheathing Boards should be butted up when using Glasroc X Sealing Tape White. The tape should be installed in temperatures between -10 °C and +45 °C.

Ensure Glasroc X Sealing Tape White is applied without wrinkling. If joints or edges require re-taping, these can be overlapped with additional tape. Do not attempt to remove incorrectly applied tape to avoid damaging the Glasroc X Sheathing Board. Glasroc X Sealing Tape White has a Reaction to Fire classification of Class E.

Products, such as tapes, are currently exempt from the Reaction to Fire requirement of A2-s1,d0 or better under current Building Regulation 7(3)(h).

Glasroc X Sheathing Board Installation Guide

Glasroc X Sealant Guidance



Completed Steel Frame System (SFS) framework ready to receive the Glasroc X Sheathing Board.



Before offering any boards into position, a continuous 6 mm wide bead of Glasroc X Sealant is needed along the vertical edge of the surface that the first sheet of Glasroc X Sheathing Board will abut.



Use Glasroc X Screws 25 mm to fix Glasroc X Sheathing Board to the SFS framework.



Run a continuous 6 mm wide bead of Glasroc X Sealant along the installed Glasroc X Sheathing Boards exposed edges, which will have other boards abutting against it.

Glasroc X Sheathing Board Installation Guide

Glasroc X Sealant Guidance



Abut subsequent sheets of Glasroc X Sheathing Board up to the previous one ensuring the sealant “mushrooms” out onto the face of the board, fully sealing the joint.



Isovler Polterm Max Plus to be fixed through the Glasroc X sheathing board into the SFS framework.

General Sealant Guidance

Glasroc X Sealant has a Reaction to Fire classification of Class E. Products, such as sealants, are currently exempt from the Reaction to Fire requirement of A2-s1,d0 or better under current Building Regulation 7(3)(h).

Glasroc X Sheathing Board Installation Guide

Breather Membrane Guidance



Is a Breather membrane required with Glasroc X Sheathing Board?

Glasroc X Sheathing Boards have been tested in accordance with EN ISO 12572 : 2001 and have a water vapour resistance of 0.448 MN·s·g⁻¹.

Glasroc X Sealing Tape White has been tested in accordance with EN 1931 and have a water vapour resistance of 0.48 Sd. The tape also achieves Class W1 water penetration resistance tested in accordance to BS EN 13984.

Glasroc X Sheathing Boards, if installed correctly with joints and perimeters sealed, provide sufficient weather-proofing as certified by the BBA, potentially eliminating the need for a breather membrane.

The specification, positioning and use of a breather membrane will vary according to full construction and may need to be evaluated by competent persons in accordance with Approved Document C and BS 5250.

Glasroc X Sheathing Board Installation Guide

Breather Membrane Guidance

Additional information on breather membranes

Breather membranes are resistant to liquid water penetration but vapour permeable. They may be used within external wall constructions where the external cladding may not be completely water-tight or moisture resistant, such as framed wall constructions.

A breather membrane allows for water vapour to escape from inside the construction while preventing water ingress. Breather membranes are correctly positioned on the outer side of insulation.

Air and vapour control layers (VCLs) restrict the passage of warm, moist air from the inside of a building preventing build up of condensation in the cavity. Vapour control layers are normally positioned on the inner side of insulation.

Breather membranes do not improve breathability.

Water Penetration Resistance Classes

Membranes that achieve W1 are used in open applications where the breather membrane is directly exposed to the elements. Membranes that achieve W2 are used in protected applications, such as behind cladding or a rainscreen system, where the breather membrane is not directly exposed to the elements.

A Typical Through-Wall Infill SFS System

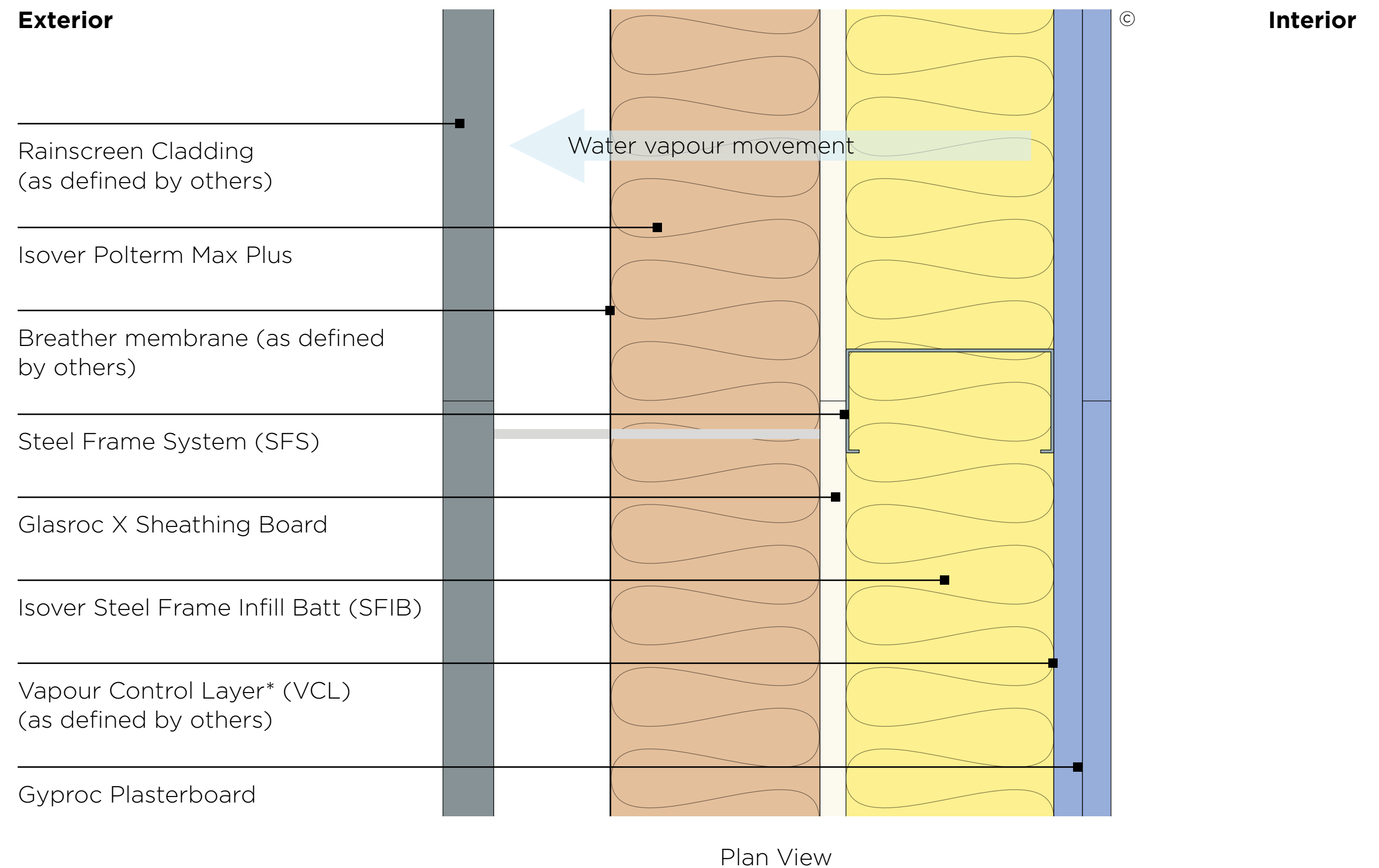

* Breather membrane and Vapour Control Layer positioning and specification will vary according to full construction and may need to be evaluated by competent persons in accordance with Approved Document C and BS 5250.

Glasroc X Sheathing Board Installation Guide

Exposed Edges and Window Openings Guidance

If using Glasroc X Sealing Tape White, Ethylene Propylene Diene Monomer (EPDM) is not mandatory as the Glasroc X Sealing Tape White can be used to seal exposed/cut edges and window openings before window framing is installed.

EPDM will still be required for sufficient sealing between Glasroc X Sheathing Boards and window framing.

Hot applied EPDM should not be used on Glasroc X Sheathing Boards. .

Specifying an EPDM

The areas between Glasroc X Sheathing Boards and window framing require additional sealing to ensure waterproofing and weather protection. A suitable EPDM should be installed correctly to sufficiently protect these areas.

When selecting a suitable EPDM, it is recommended to use an EPDM that conforms to EN 13984. Contact should be made to the EPDM manufacturer for specific guidance on the application.



Glasroc X Sheathing Board Installation Guide

Health and Safety



For safe handling it is recommended that Glasroc X Sheathing Boards, tape or sealant are not installed in high winds where increased risk factors may be present. Employers should carry out a risk assessment and implement control measures to avoid or minimise the risk of injury.

Before cutting Glasroc X Sheathing Boards, employers should carry out a risk assessment and implement control measures to avoid or minimise the risk of injury.

Harmful dust may be released during cutting process. Dust may irritate the eyes and the respiratory system. Frequent inhalation of dust over a long period of time increases the risk of developing lung diseases. Employers should carry out a risk assessment and implement control measures to avoid or minimise the risk of injury.

British Gypsum fully accepts its responsibilities as a supplier of building materials and systems as required by Section 6 of the Health and Safety at Work etc. Act 1974.

To reduce manual handling risk, employers and workers should follow HSE's Manual Handling Operations Regulations 1992 (MHOR) and the HSE's guidance on manual handling at work (INDG143). Employers should carry out a risk assessment and implement control measures to avoid or minimise the need for manual handling. Workers should follow safe lifting and moving techniques and report any hazards. The 'Manual Handling Guide' published by the Gypsum Products Development Association (GPDA) and its member companies can provide additional plasterboard specific guidance and is available on the GPDA website.

Plasterboard handling should be assessed for risk before lifting or carrying. All British Gypsum plasterboards have safety information printed on the board. Where mechanical aids are available, they should be considered in the overall risk assessment.

Glasroc X Sheathing Board Installation Guide

Components

PRODUCT	SIZE	PACK SIZE
Glasroc X Sheathing Board 	1200 x 2400 x 12.5 mm	50 Boards per pallet
Glasroc X Screws 	25 mm Collated 25 mm	1000 per box 1000 per box
Glasroc X Sealing Tape White 	Length 25 m Width 60 mm	1 roll (10 rolls per carton box)
Glasroc X Sealant 	0.6 litres per cartridge	12 cartridges per carton

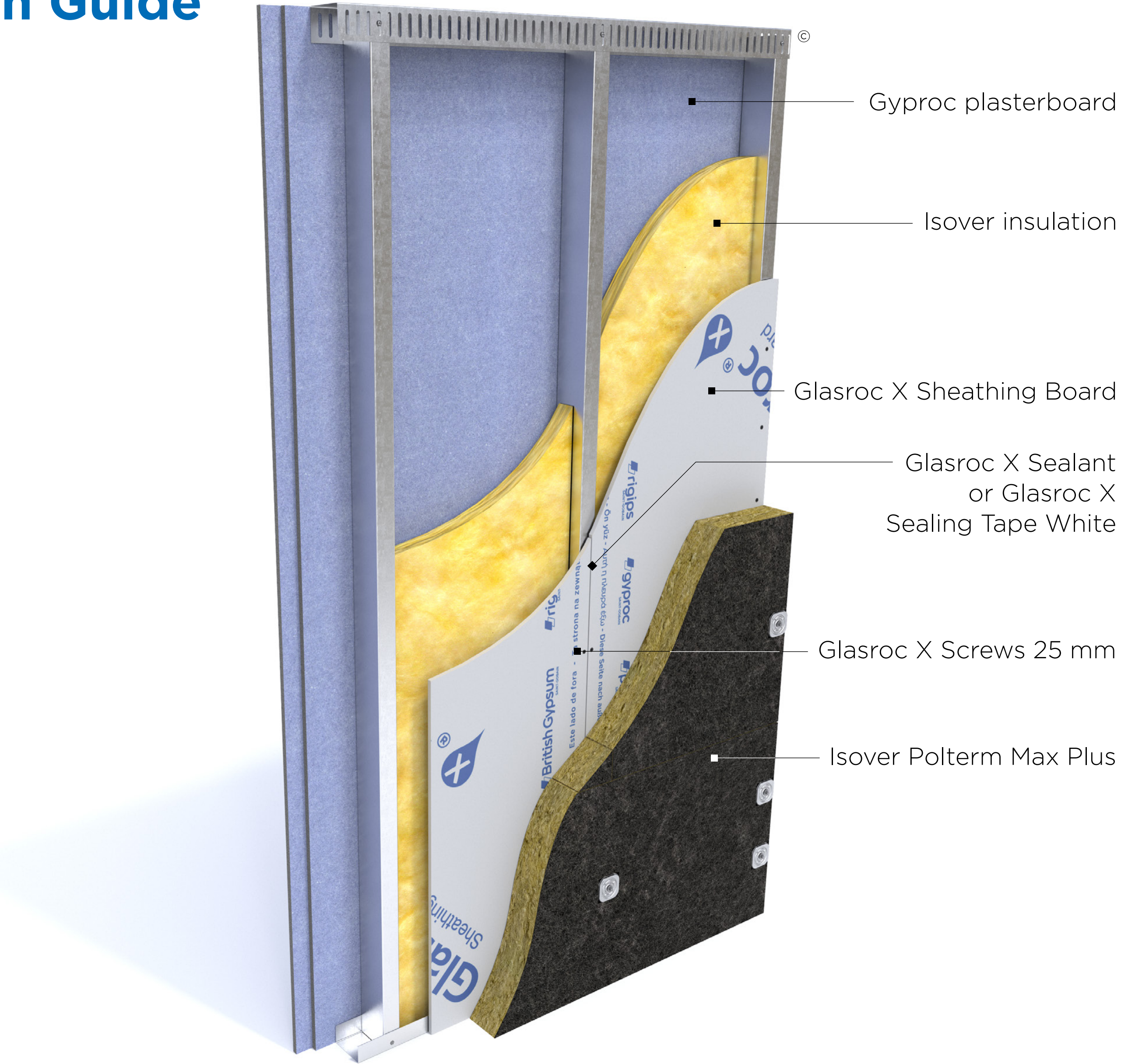



British Gypsum

**Head Office, East Leake,
Loughborough,
Leicestershire, LE12 6HX
T: 0115 945 1000**

british-gypsum.com



“Gyproc”, “Thistle”, “ThistlePro”, “Gypframe” and “Glasroc” are all registered trademarks of Saint-Gobain Construction Products UK Limited. “Isover” is a registered trademark of Saint-Gobain Isover (French legal entity) and “Okarno” is a registered trademark of Okarno Limited.

Saint-Gobain Construction Products UK Limited is a limited company registered in England under company number 734396, having its registered office at Saint-Gobain House, East Leake, Loughborough, Leicestershire, LE12 6JU, UK. Saint-Gobain Construction Products UK Limited trades as British Gypsum for part of its business activities.

British Gypsum reserves the right to revise product specification without notice. The information herein should not be read in isolation as it is meant only as guidance for the user, who should always ensure that they are fully conversant with the products and systems being used and their subsequent installation prior to the commencement of work. For a comprehensive and up-to-date library of information visit the British Gypsum website at: british-gypsum.com. For information about products supplied by Okarno Limited or Saint-Gobain Isover please see their respective websites.

“British Gypsum” is a registered trademark of Saint-Gobain Construction Products UK Limited.