

# INTERNAL PARTITIONS AND WALLS

Highly versatile lightweight, non-loadbearing partition systems. A full range of lightweight partition and wall systems for use in new and existing buildings. They cover all applications, from simple space division to high performance walls.

We offer a full range of lightweight partition and wall systems. Our systems are non-loadbearing and constructed using modern, drylining techniques. Our metal framed partitions and walls can be used in all types of new and existing buildings, including private and social housing, apartments, healthcare, educational facilities, recreational and industrial properties.

They cover all applications, from simple space division, through to high performance walls designed to meet the most demanding fire resistance, sound insulation, impact and height requirements.

Our partition systems are constructed using lightweight materials, which can offer significant savings in structural design compared to masonry alternatives. Benefits also include the speed of installation and reduction to overall build costs.



There are specifications within this system that qualify for our **SpecSure**® warranty. For more information, contact us through [british-gypsum.com](https://www.british-gypsum.com)

# Internal partitions and walls

When specifying partitions, a number of performance characteristics are normally used to determine the required solution.

Depending on the project or construction type, these performance parameters could be set by minimum regulatory standards, or a client or customer requirement for buildings that offer the highest standards of performance and comfort.

## GypWall Single Frame

Create all the rooms you need with the industry's original lightweight non-loadbearing drywall partition system. **See page 4.19.**





 Fire resistance <b>30-240 mins</b>	 Sound rating <b>34-63 R<sub>w</sub>dB</b>	 Duty rating <b>medium to severe</b>
--	---	---

For illustrative purposes only.

## GypWall Single Frame Enhanced

Keep busy areas in great condition with robust partitions. **See page 4.27.**



 Fire resistance <b>30-120 mins</b>	 Sound rating <b>38-60 R<sub>w</sub>dB</b>	 Duty rating <b>severe</b>
--	--	---

For illustrative purposes only.

## GypWall Resilient

Improve acoustic performance of your partitions and separating walls with minimal loss of floor space. **See page 4.39.**

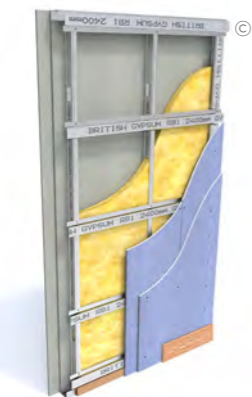





 Fire resistance <b>60-120 mins</b>	 Sound rating <b>61-65 R<sub>w</sub>dB</b>	 Duty rating <b>severe</b>
--	---	---

For illustrative purposes only.

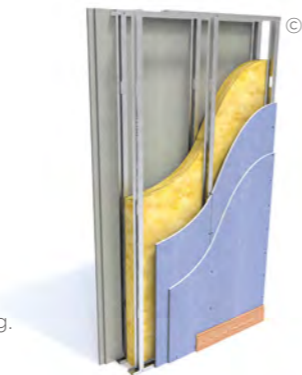
## GypWall Twin Frame Independent

Reduce sound transmission without the need for pre-completion testing. **See page 4.51.**



 Fire resistance <b>90-120 mins</b>	 Sound rating <b>63-70 R<sub>w</sub>dB</b>	 Duty rating <b>severe</b>
--	--	---

For illustrative purposes only.

## Additional information

Try out The White Book Specification Selector, an online tool designed to help find the ideal solutions for your project needs. Additional information such as BIM data (Revit), Technical Specifications, CAD drawings and other associated items can be downloaded. Visit [british-gypsum.com](http://british-gypsum.com)



## GypWall Twin Frame Braced

Keep the peace by reducing sound transmission through separating walls. **See page 4.63.**

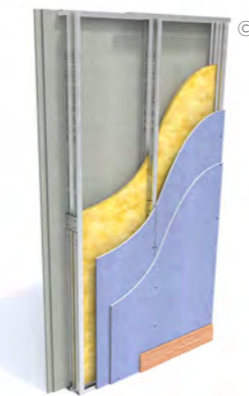



 Fire resistance <b>60-120 mins</b>	 Sound rating <b>58-65 R<sub>w</sub>dB</b>	 Duty rating <b>severe</b>
--	---	---

For illustrative purposes only.

## GypWall Twin Frame Audio

Build an acoustic sanctuary without losing floor space. **See page 4.75.**







 Fire resistance <b>60-120 mins</b>	 Sound rating <b>67-80 R<sub>w</sub>dB</b>	 Duty rating <b>severe</b>
--	---	---

For illustrative purposes only.

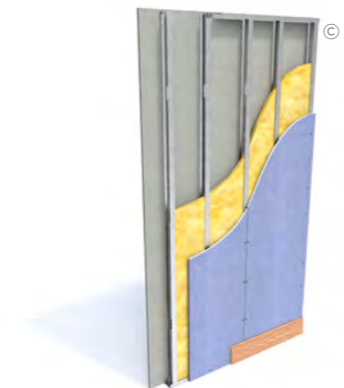
## GypWall Staggered

Space-saving sound insulation. **See page 4.89.**



 Fire resistance <b>30-90 mins</b>	 Sound rating <b>49-63 R<sub>w</sub>dB</b>	 Duty rating <b>heavy to severe</b>
---	---	--

For illustrative purposes only.

# Internal partitions and walls

## Good practice specification guidance

To maximise the performance achieved on site, consider the following good practice specification guidance:

- Consider flanking transmission at the design stage and ensure construction detailing is specified to eliminate, or at least to minimise, any downgrading of the acoustic performance
- Small openings such as gaps, cracks or holes will conduct airborne sounds and can significantly reduce the sound insulation of a construction. For optimum sound insulation a construction must be airtight
- When designing the layout of rooms requiring separation by sound insulating walls abutting structural steelwork, consideration should be given to the potential loss of sound insulation performance through the steelwork
- Deflection heads, by definition, must be able to move and, therefore, achieving an airtight seal is very difficult without incorporating sophisticated components and techniques. Air leakage at the partition heads will have a detrimental effect on acoustic performance of any partition. Where acoustic performance is a key consideration, steps must be taken to minimise this loss of performance
- A common mistake made when designing a building is to specify a high performance element and then incorporate a lower performing element within it; for example, a door within a partition. Where the difference between insulation is relatively small (7dB or less), there needs to be a comparatively large area of the lower insulation element before the overall sound insulation is significantly affected. However, where there is a greater difference in sound insulation performance between the two elements, this would usually result in a greater reduction of overall sound insulation performance

Table 1 - Sound insulation performance for residential specification			
Approved Document E (England and Wales)	On-site	Laboratory**	
	$D_{nT,w} + C_{tr}$ dB	Minimum solution $(R_w + C_{tr})$ dB	Recommended solution $(R_w + C_{tr})$ dB
Separating walls between new homes	45	(49)	(54)
Separating walls between purpose-built rooms for residential purposes and rooms created by a change of use or conversion	43	(47)	(52)
Technical Standards Section 5 (Scotland)			
	On-site	Laboratory**	
	$D_{nT,w} + C_{tr}$ dB	Minimum solution $R_w$ dB	Recommended solution $R_w$ dB
Separating walls between new homes, purpose-built for residential purposes and conversions (not including traditional buildings*)	56	60	63
Separating walls between rooms created by a change of use or conversion (traditional buildings*)	53	57	60

\* Definition of traditional buildings - A building or part of a building of a type constructed before or around 1919: a) using construction techniques that were commonly in use before 1919; and b) with permeable components, in a way that promotes the dissipation of moisture from the building fabric.

\*\* Minimum solutions provide little or no margin of safety to allow for reduction in performance due to flanking transmission. Recommended solutions have greater potential to satisfy the requirements of Building regulations.

# GypWall partitions

## Construction details

To be read in conjunction with system specific details. Refer to relevant system sections.

### 1. Stud splicing detail

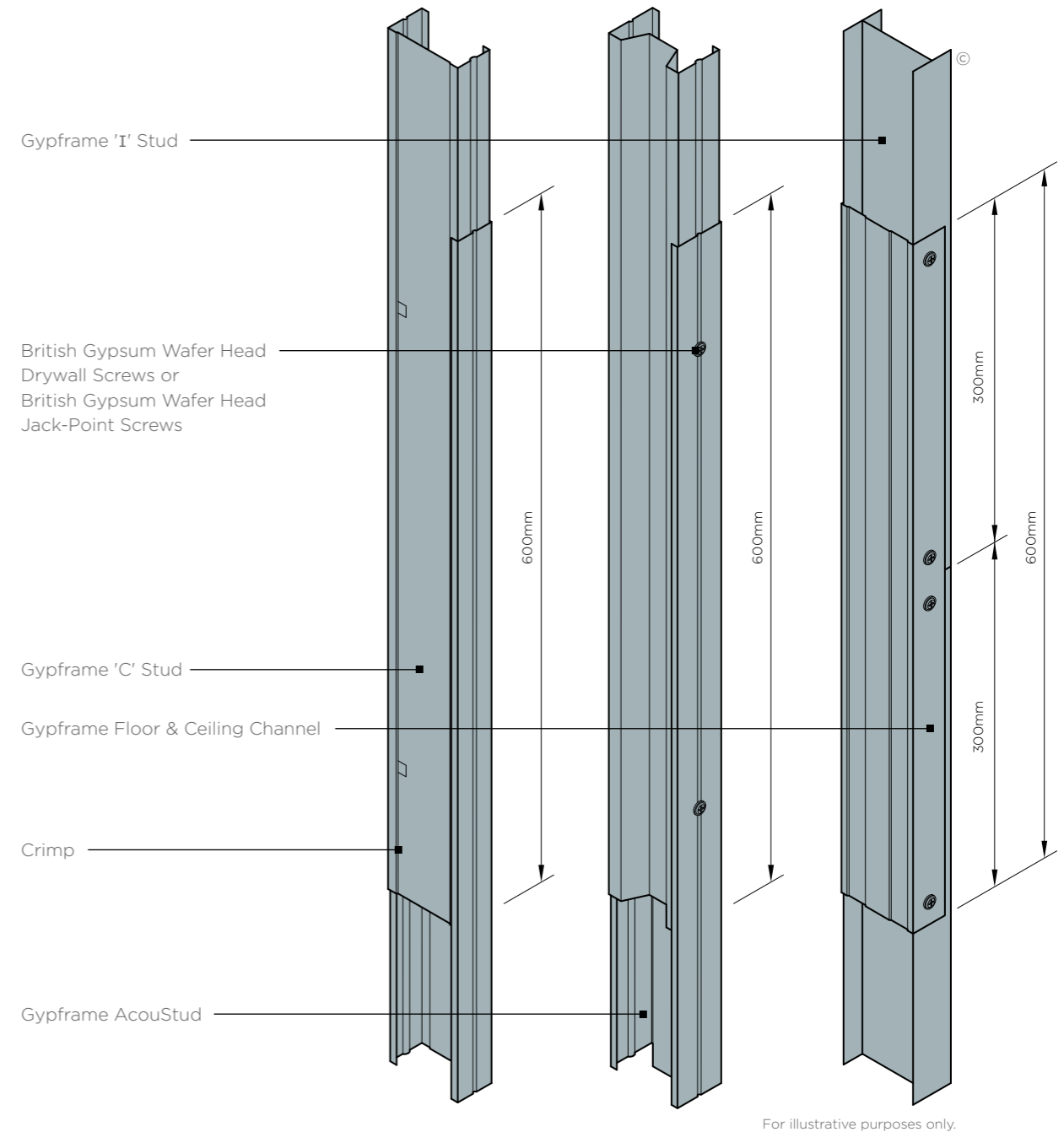

# GypWall partitions

## Construction details

To be read in conjunction with system specific details. Refer to relevant system sections.

### 2. Fully boxed Gypframe 'C' Stud

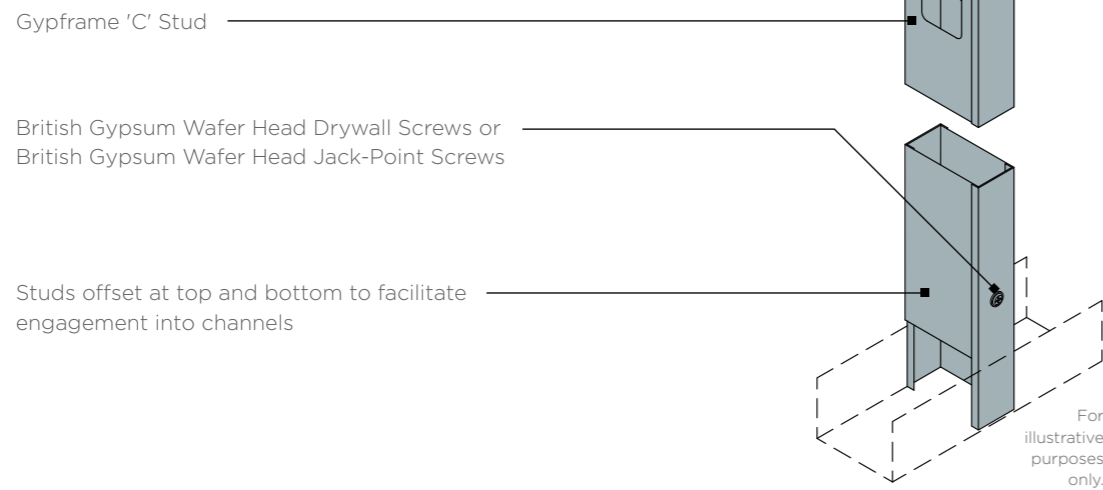

### 3a. Service cut-outs Gypframe 'C' and Gypframe 'I' Studs

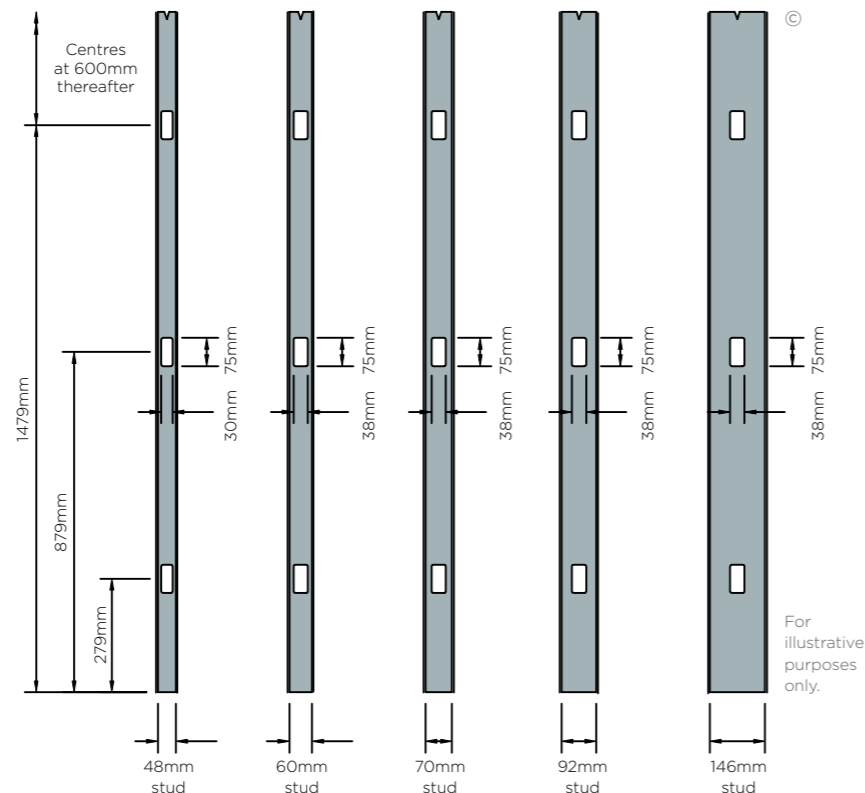

### 3b. Service cut-outs Gypframe AcouStuds

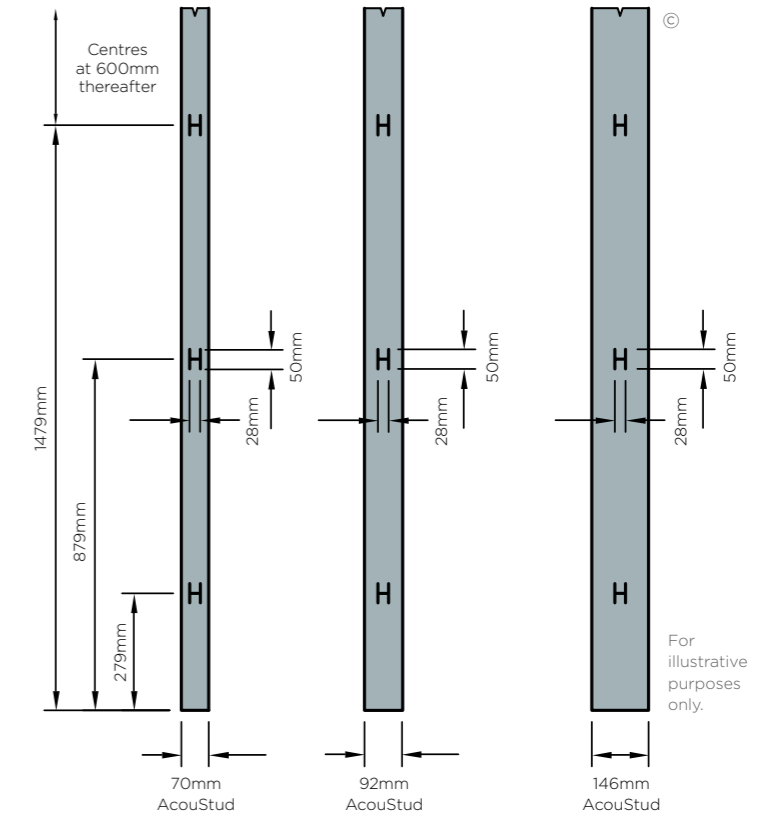

### 4. Junction with masonry and stop end detail

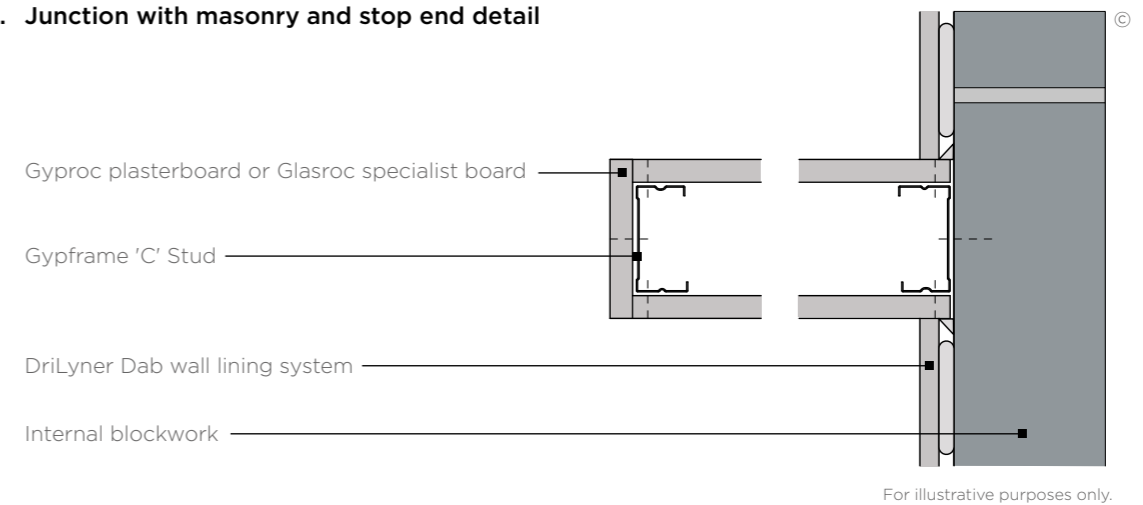

# GypWall partitions

## Construction details

To be read in conjunction with system specific details. Refer to relevant system sections.

### 5a. Head and base

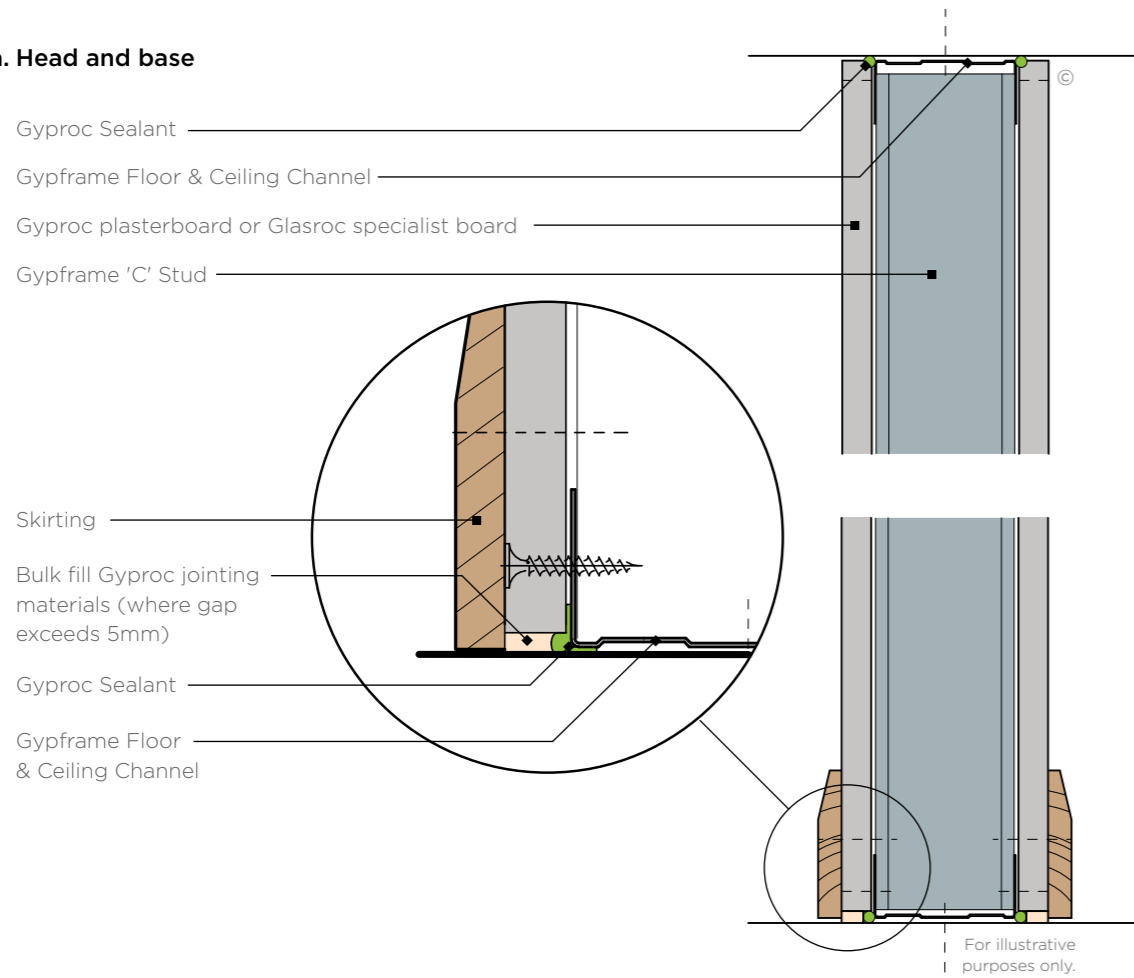

### 5b. Base with timber sole plate

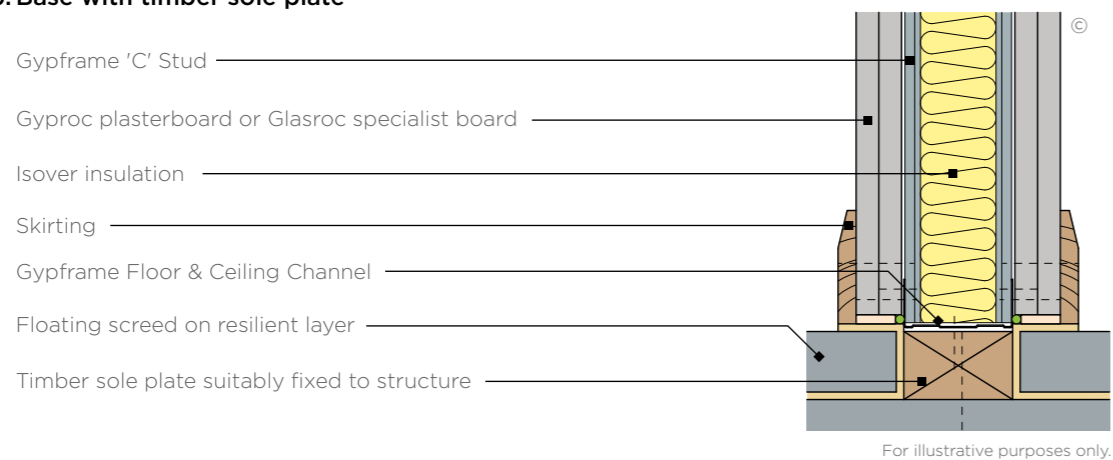

### 6a. 'T' junction Single layer

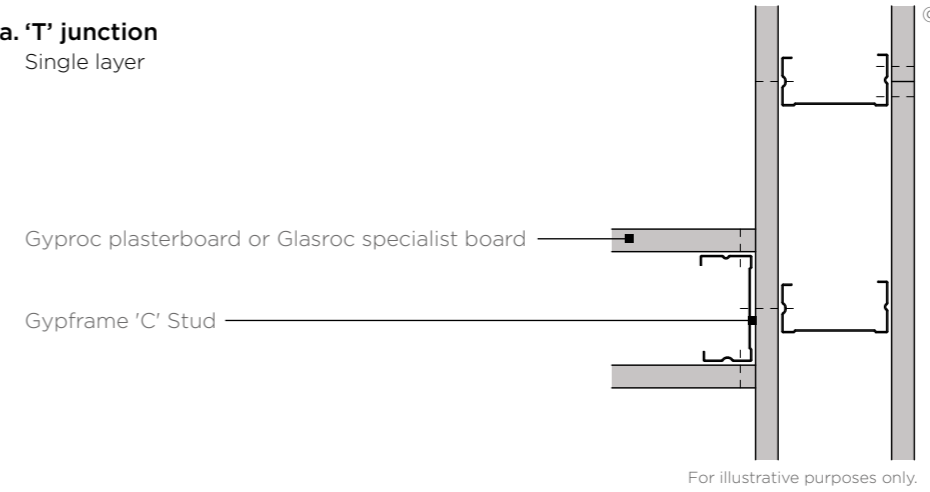

### 6b. 'T' junction

When partition with higher acoustic performance abuts a partition with lower acoustic performance. Acoustic principles only - detail may not be suitable for all solutions

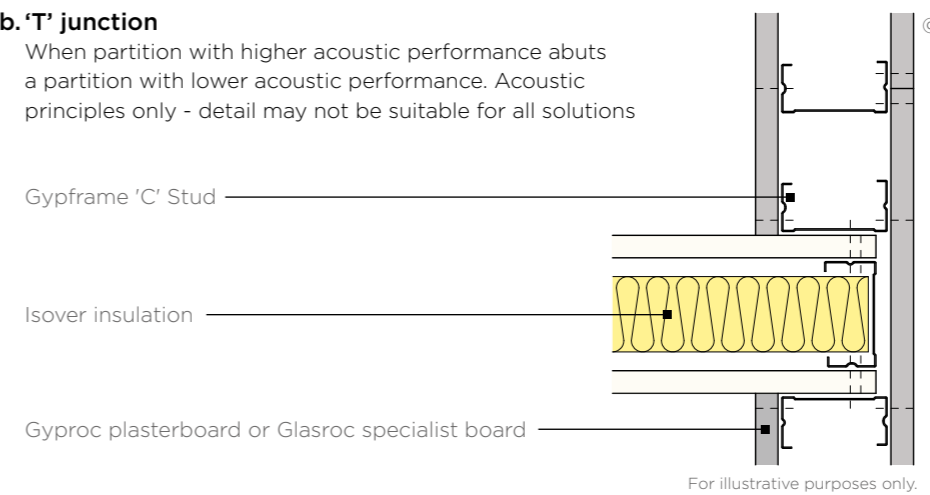

### 6c. 'T' junction

To optimise acoustic performance and reduce flanking transmission

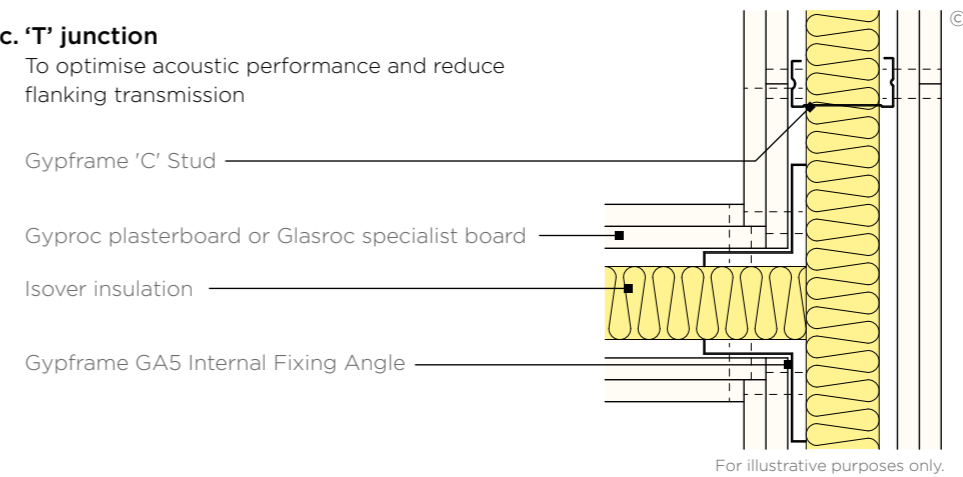

Guidance must be sought from the relevant approval authority e.g. Building Control to establish if a cavity barrier is required (Approved Document B)

# GypWall partitions

## Construction details

To be read in conjunction with system specific details. Refer to relevant system sections.

### 6d. 'T' junction

To optimise acoustic performance and reduce flanking transmission

- Gyproc plasterboard or Glasroc specialist board
- Gypframe 'C' Stud
- Isover insulation

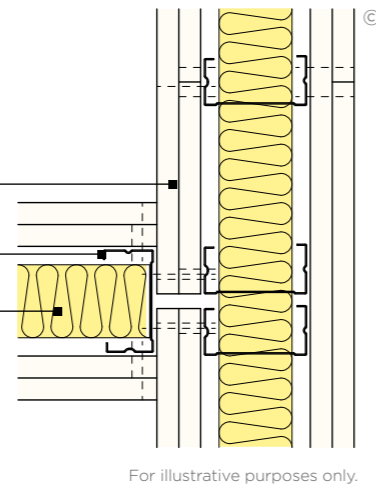

### 7. Four way junction

To optimise acoustic performance and reduce flanking transmission

- Gyproc plasterboard or Glasroc specialist board
- Isover insulation
- Gypframe 'C' Stud

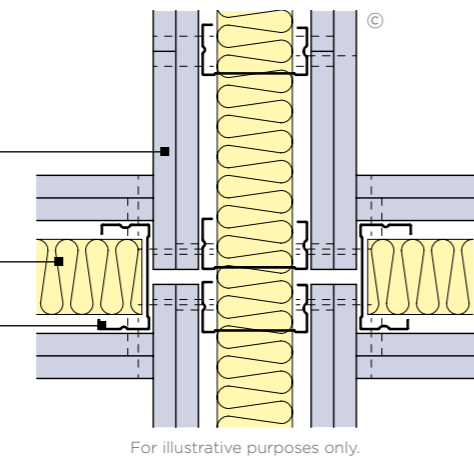

### 8. Splayed corner

- Gyproc plasterboard or Glasroc specialist board
- Gypframe GA5 Internal Fixing Angle
- Gypframe 'C' Stud
- Gypframe GA6 Splayed Angle

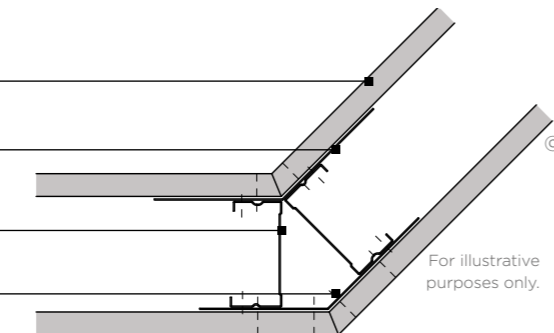

### 9. Corner detail

Single layer

- Gyproc plasterboard or Glasroc specialist board
- Gypframe 'C' Stud

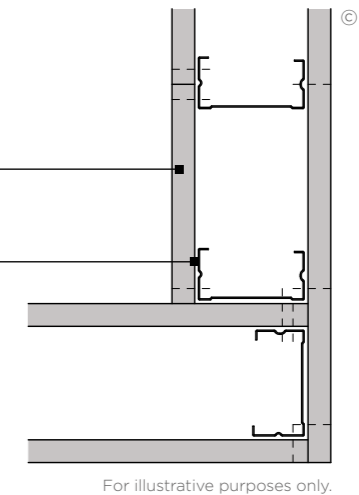

### 10. Corner detail

Double layer

- Gyproc plasterboard or Glasroc specialist board
- Gypframe 'C' Stud

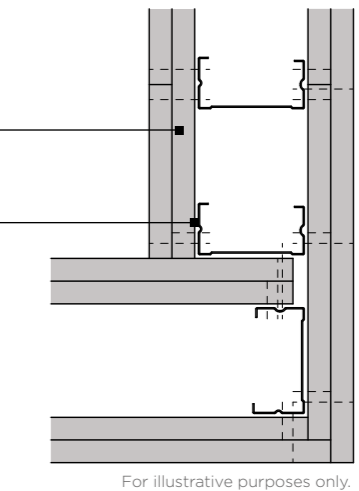

### 11. Typical control joint

- Gyproc plasterboard or Glasroc specialist board
- Gypframe 'C' Stud
- Stone mineral wool (density as per specification)
- Gyproc Control Joint

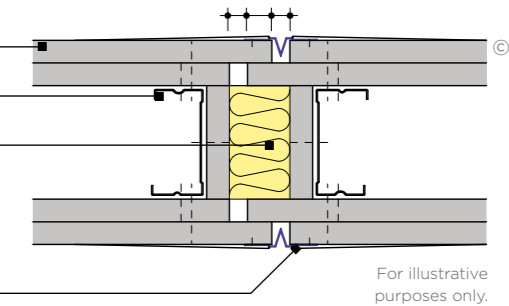

Guidance must be sought from the relevant approval authority e.g. Building Control to establish if a cavity barrier is required (Approved Document B)

# GypWall partitions

## Construction details

To be read in conjunction with system specific details. Refer to relevant system sections.

### 12. Gypframe 99 FC 50 Fixing Channel

Short legs flattened at stud positions

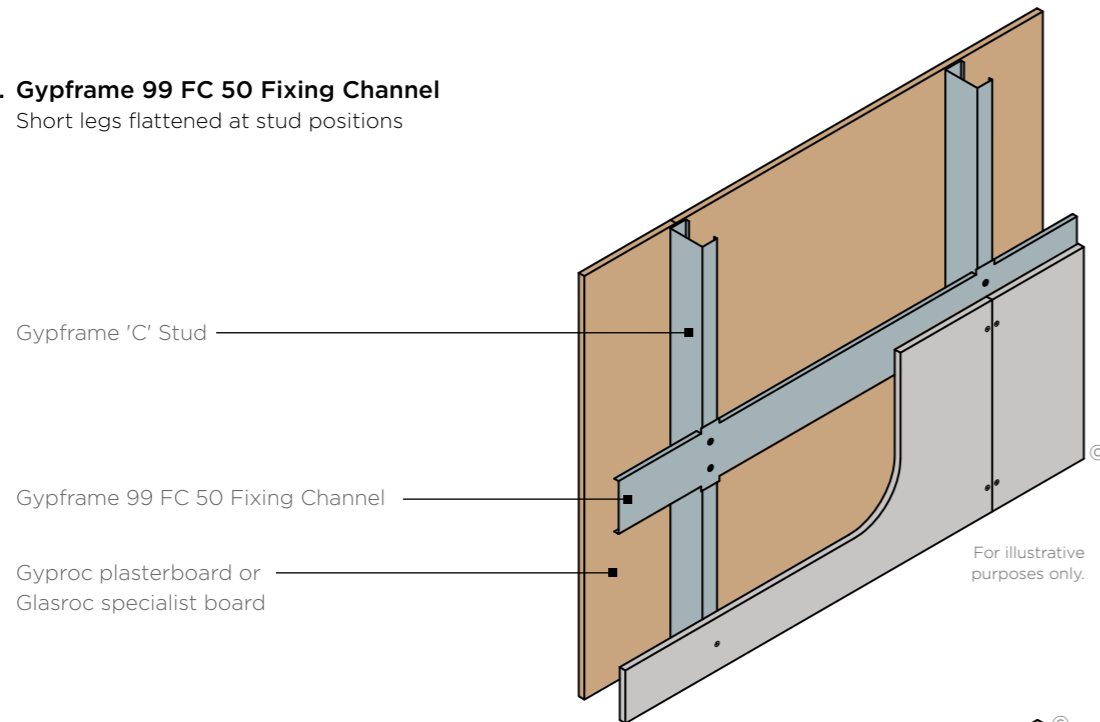

### 13. Gypframe Service Support Plate

Gypframe 'C' Stud

Gypframe Service Support Plate

18mm plywood

Gyproc plasterboard or Glasroc specialist board

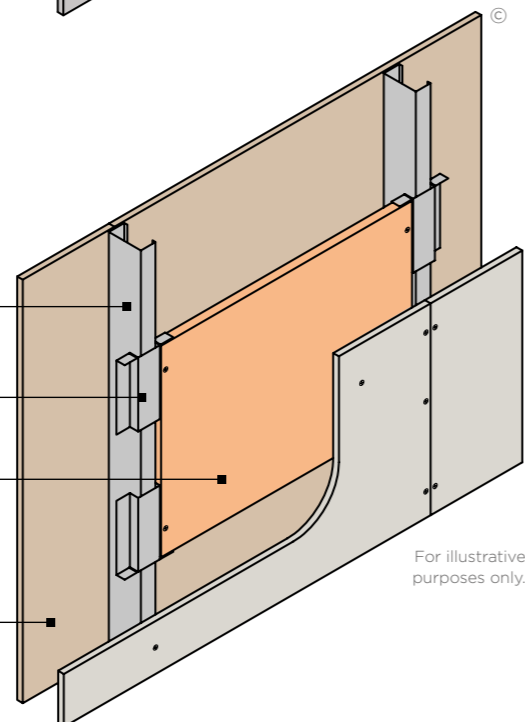

Installing the screw into the side of the Gypframe Service Support Plate and the web of the Gypframe 'C' Stud will avoid creating excessive distortion to the lining board.

© British Gypsum, 2026.

### 14. Deflection head

25mm downward movement and 60 minutes fire resistance to BS EN 1364-1

- Gyproc FireStrip
- Two channel-width Glasroc F strips pre-fixed with suitable British Gypsum Screws at 600mm centres
- Gyproc Sealant
- Gypframe Deep Flange Floor & Ceiling Channel suitable fixed through fire stop to structure
- Gypframe Steel Angle
- Gypframe GFS1 Fixing Strap
- Two layers of Gyproc plasterboard
- Gypframe 'C' Stud
- Isover insulation where required
- Two 50mm width strips of Glasroc F FireCase fixed to soffit with suitable fire resistant fixings at 600mm centres

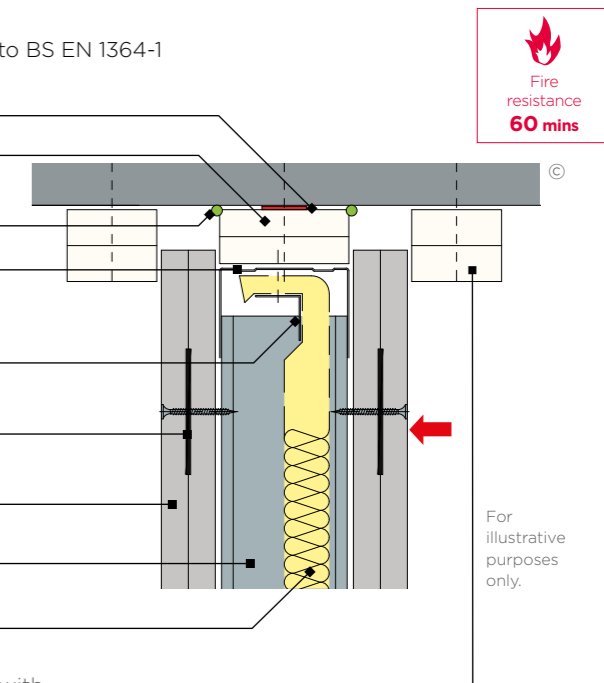

### 15. Deflection head

25mm downward movement and 120mins fire resistance to BS EN 1364-1

- Gyproc FireStrip
- Two channel-width Glasroc F strips pre-fixed with suitable British Gypsum Screws at 600mm centres
- Gyproc Sealant
- Gypframe Deep Flange Floor & Ceiling Channel suitable fixed through fire stop to structure
- Stone mineral wool 33kg/m<sup>3</sup> minimum density by others
- Gypframe Channel noggings
- Two layers of Gyproc FireLine
- Gypframe Steel Angle
- Gypframe 'C' Stud
- Isover insulation where required
- Two 50mm width strips of Glasroc F FireCase fixed to soffit with suitable fire resistant fixings at 600mm centres

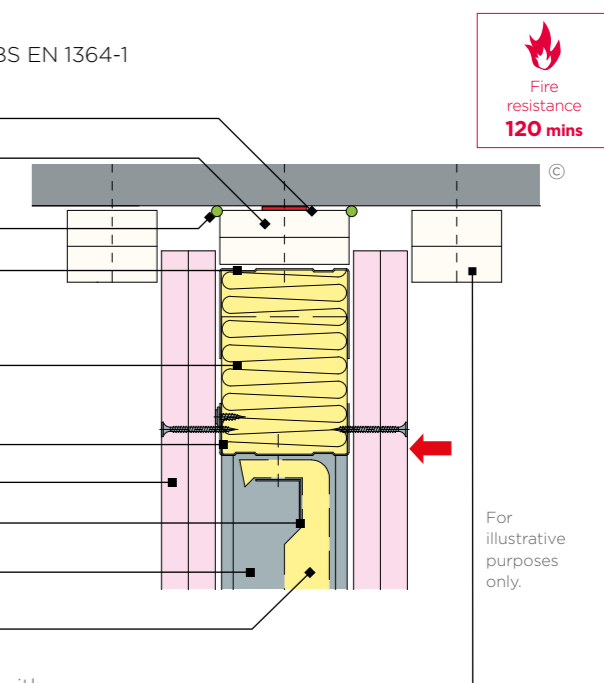

N.B. No fixings should be made through the boards into the flanges of the head channel. The arrow (→) denotes the position of the uppermost board fixing, which should be made into Gypframe GFS1 Fixing Strap. Continuous Gyproc FireStrip must be installed as shown to maintain fire performance.

© British Gypsum, 2026.

# GypWall partitions

## Construction details

To be read in conjunction with system specific details. Refer to relevant system sections.

### 16. Door frame (maximum 1200mm width) to satisfy BS 5234: Parts 1 & 2: 1992 Light and Medium Duty (up to 35kg door)

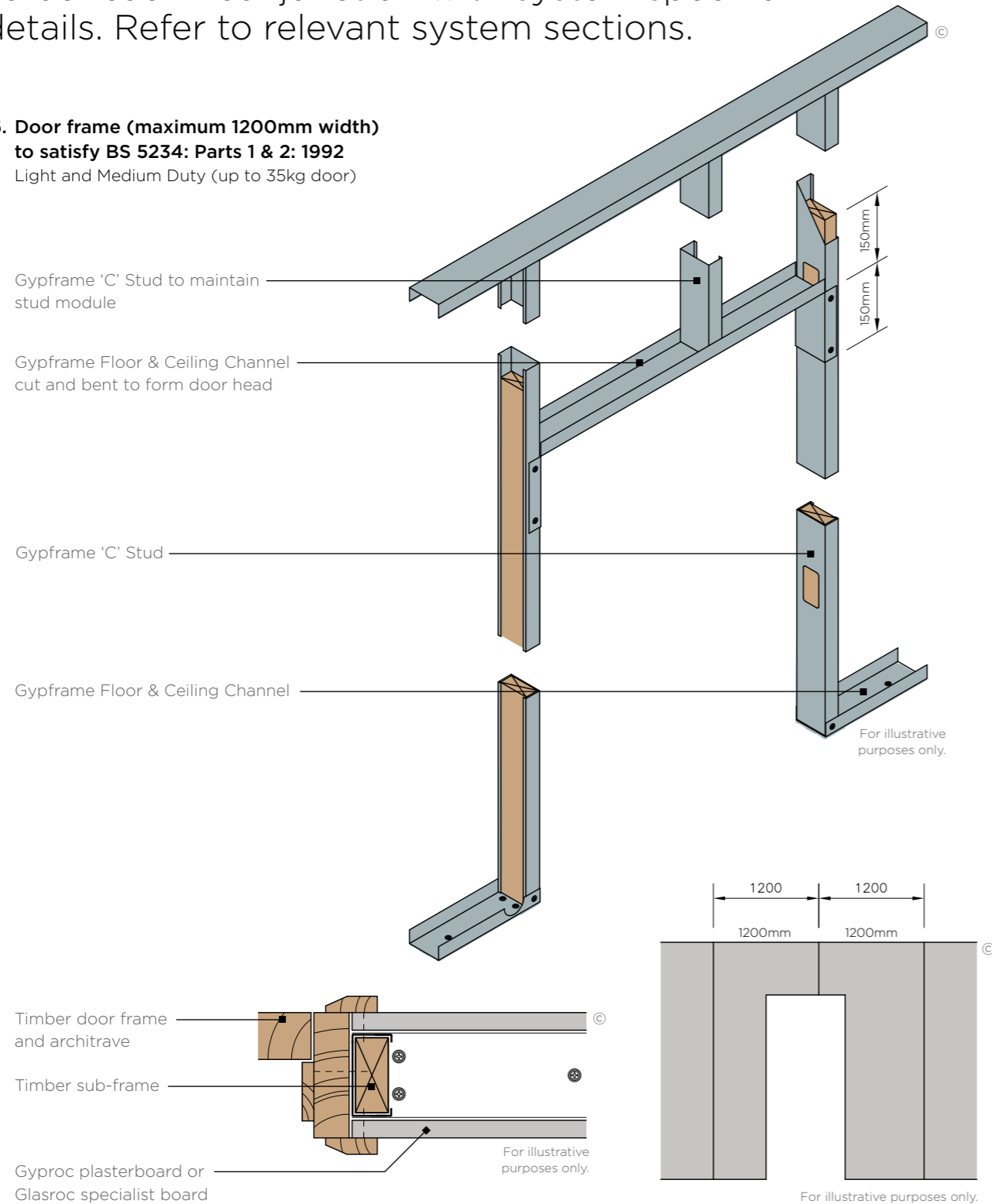

Advice should be sought from the door manufacturer before the construction of these details.

### 17. Door frame (maximum 1200mm width) to satisfy BS 5234: Parts 1 & 2: 1992 Heavy and Severe Duty (up to 60kg door)

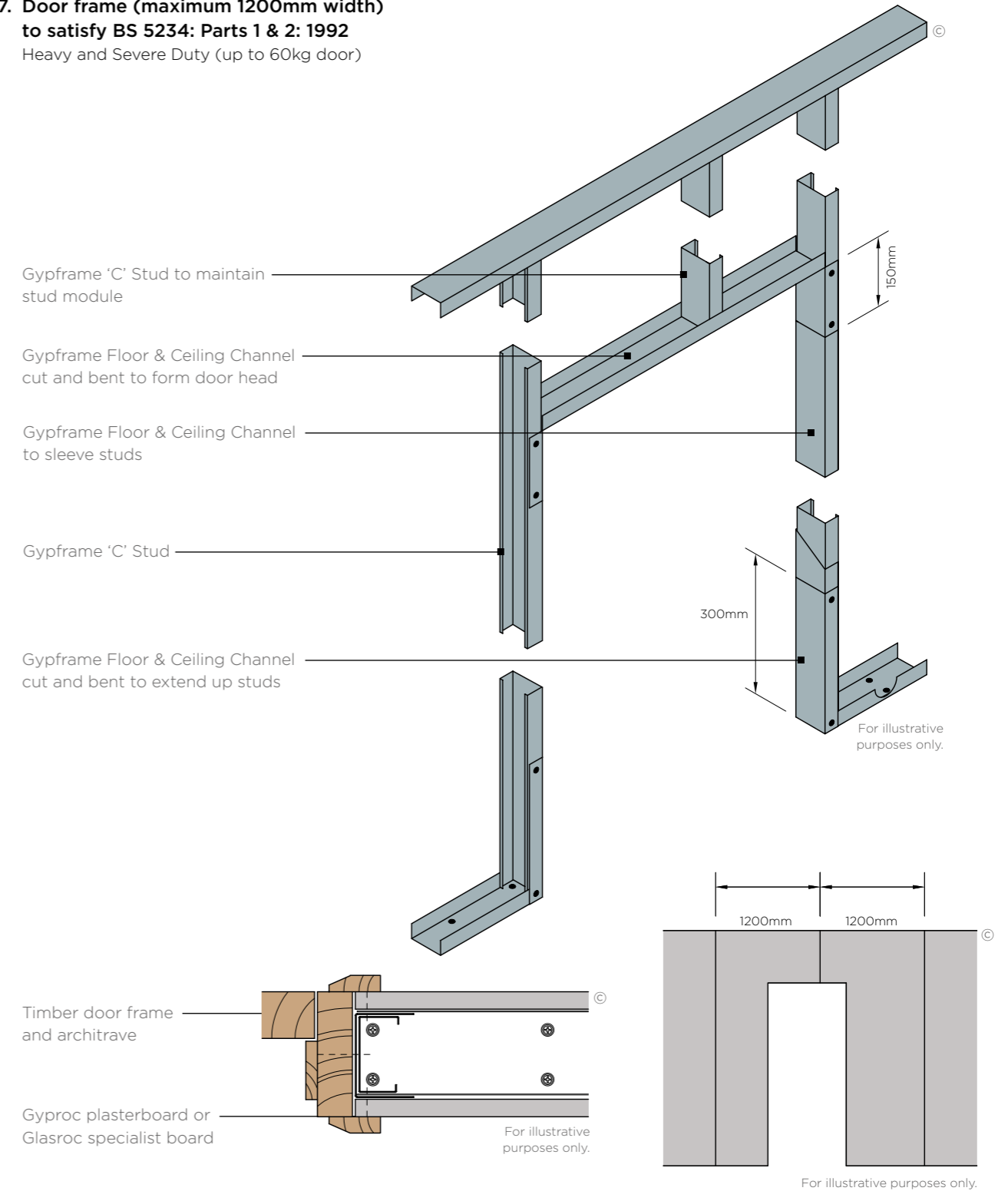

Advice should be sought from the door manufacturer before the construction of these details. At the base, the channel is cut and bent to extend 300mm up the studs and fixed each side with two British Gypsum Wafer Head Drywall Screws. The studs each side of the opening are sleeved full height of opening with Gypframe Floor & Ceiling Channel.

# GypWall partitions

## Construction details

To be read in conjunction with system specific details. Refer to relevant system sections.

### 18a. Openings

1201-3300mm wide, for example double doors or large windows

Gypframe studs (appropriate to system)

Gypframe stud insert

Gypframe Extra Deep Flange Floor & Ceiling Channel

Stud sleeved to full opening height with Gypframe Floor & Ceiling Channel

Gypframe 'C' Stud

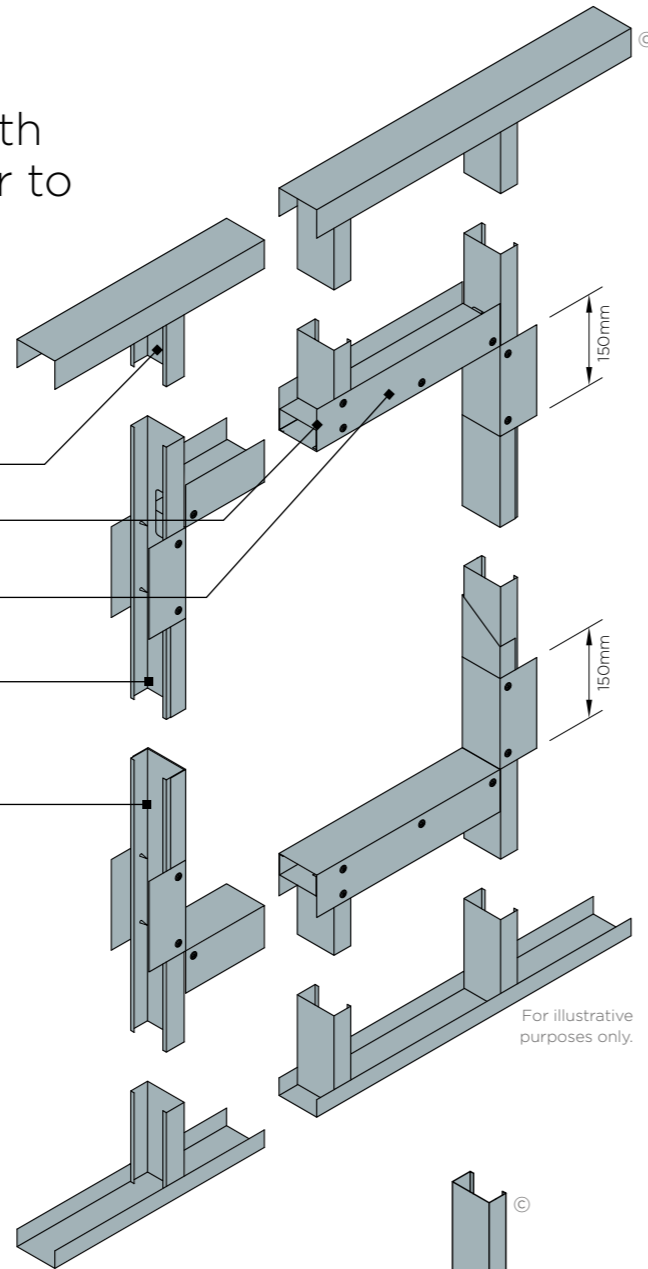

For illustrative purposes only.

### 18b. Opening up to 600mm wide for services

Gypframe 'C' Stud

Gypframe Folded Edge Standard Floor & Ceiling Channel cut and bent to form opening head and cill

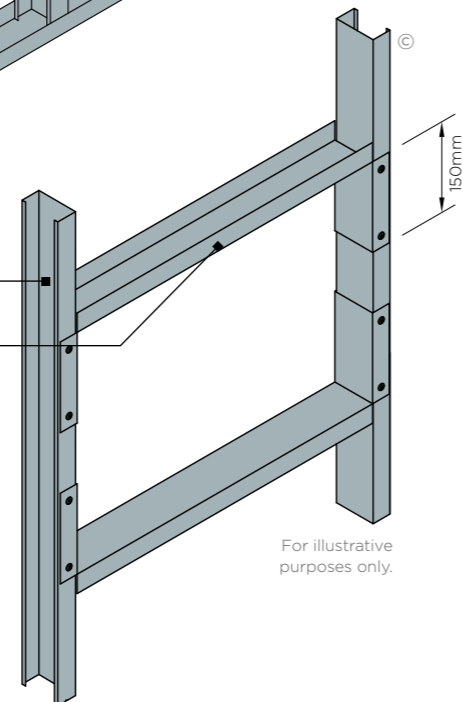

For illustrative purposes only.

Non-fire rated openings, for fire rated opening details refer to our best practice guidance

© British Gypsum, 2026.

### 19. Board layout - typical configuration

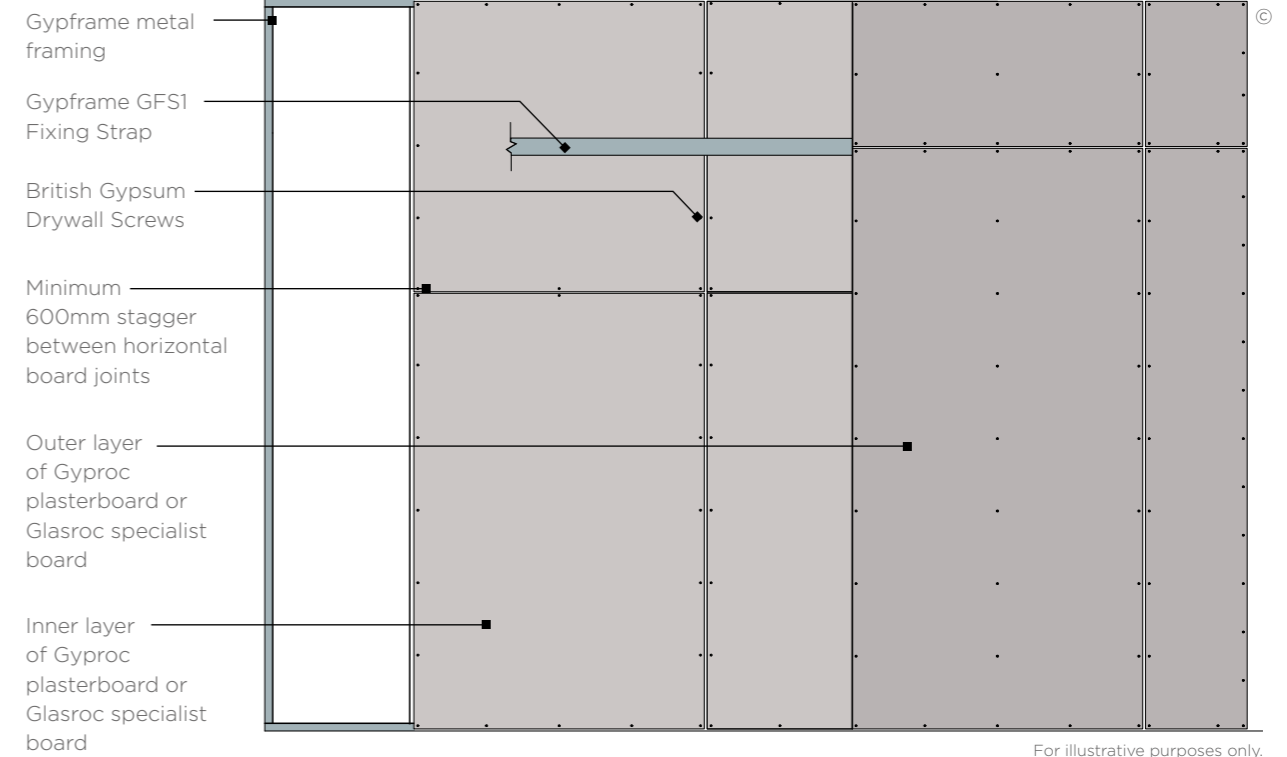

For illustrative purposes only.

### 20. Horizontal board joint

Double layer

Outer layer of Gyproc plasterboard or Glasroc specialist board

Gypframe GFS1 Fixing Strap

Gypframe 'C' Stud

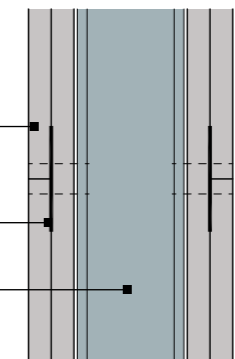

For illustrative purposes only.

### 23. Horizontal board joint

Single layer

Gyproc plasterboard or Glasroc specialist board

Gypframe GFT1 Fixing T (alternatively use Gypframe GSF1 Fixing Strap)

Gypframe 'C' Stud

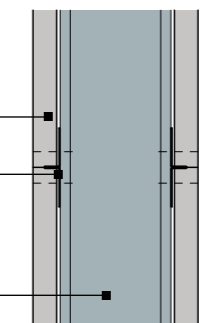

For illustrative purposes only.

© British Gypsum, 2026.

# GypWall Resilient Identification

Improve the acoustic performance of your partitions and separating walls with minimal loss of floor space.

GypWall Resilient is a non-loadbearing partition system that provides high levels of sound insulation within a narrow footprint.

GypWall Resilient has the potential to achieve sound insulation requirements for separating walls. It makes spaces sound better while taking up less room, meaning it's ideal for busy places like schools and hospitals, as well as new homes.

This system can be skim finished with ThistlePro® PureFinish which contains ACTIVair®. ACTIVair makes indoor air healthier by eliminating up to 70% of formaldehyde present in indoor air.



Why specify GypWall Resilient?

Simple to install single frame system

GypWall Resilient systems give your building the protection of our **SpecSure®** lifetime warranty

Severe duty rating with narrow footprint

Airborne sound insulation performance up to 65dB

Improve acoustic performance by skimming with Thistle MultiFinish plaster on selected specifications

Save floor space with slim partitions that reduce noise

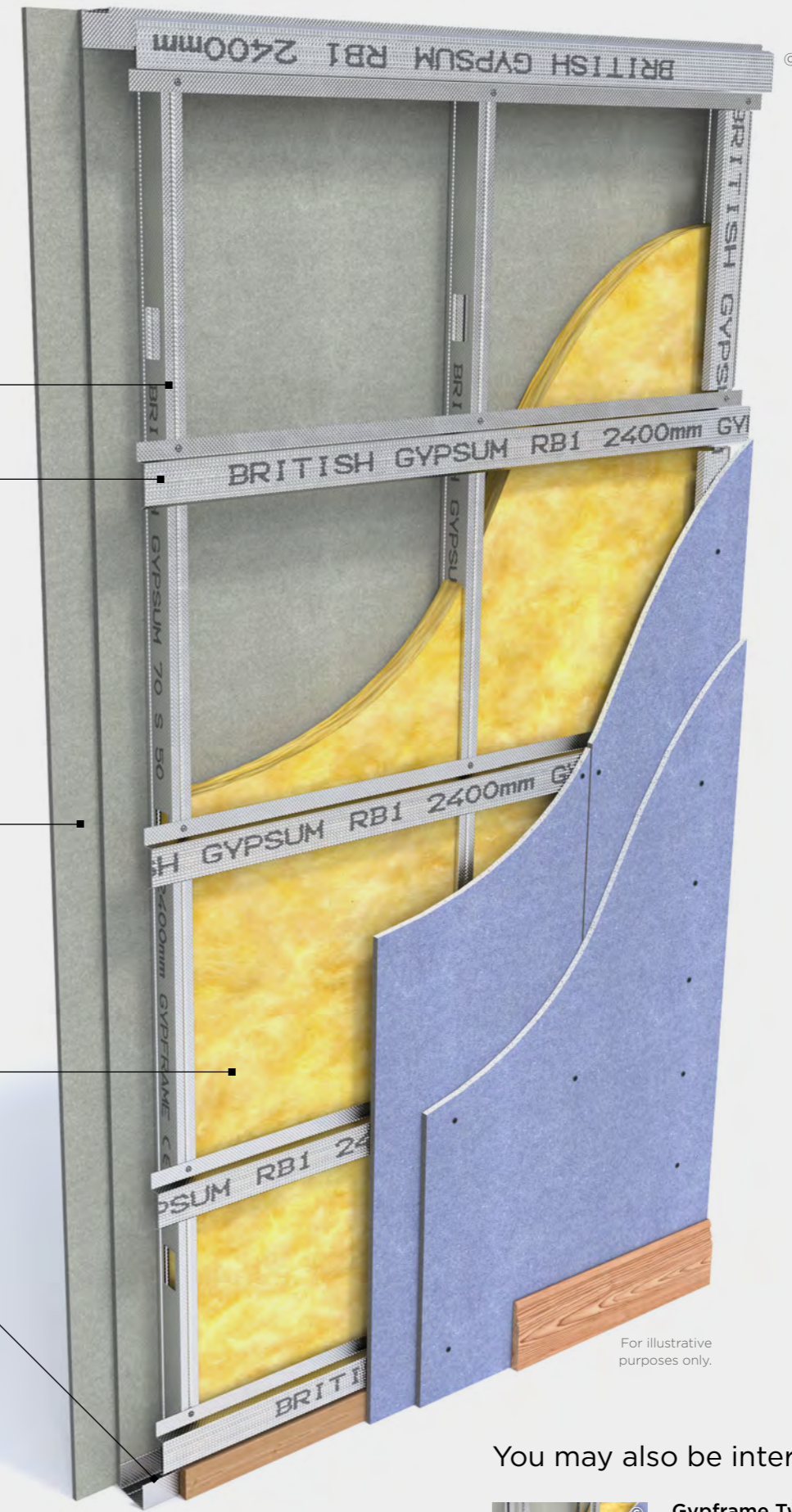

There are specifications within this system that qualify for our **SpecSure®** warranty. For more information, contact us through [british-gypsum.com](http://british-gypsum.com)

© British Gypsum, 2025.

You may also be interested in...

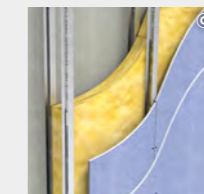

**Gypframe Twin Frame Independent**  
Looking for an unbraced twin-frame system for separating walls where greater levels of acoustic insulation are needed. **See page 4.51.**

# GypWall Resilient

## Design considerations

GypWall Resilient comprises Gypframe 'C' Studs, installed at 600 mm centres, within Gypframe Floor & Ceiling Channels. Gypframe RB1 Resilient Bars are then horizontally fixed to either one or both sides.

### Planning – key factors

Predetermine the positioning and installation of service penetrations and heavy fixtures before the frame erection stage. Consider Timber sole plates where the floor is uneven. All penetrations will require fire stopping.

#### Handy hint

When working to centre lines on a plan, please note that GypWall Resilient systems, incorporating a Gypframe RB1 Resilient Bar on one side only, are not symmetrical.

### Fixing floor and ceiling channels

Gypframe Floor & Ceiling Channels must be securely fixed with fixings at 600 mm maximum centres. For channels of 94 mm and above, require two rows of staggered fixings: each row at 600 mm centres and each fixing 25 mm in from the flange. If the floor is uneven, use a 38 mm thick timber sole plate equal to the channel width. Consider installing a damp-proof membrane for new concrete or screeded floors between the floor surface and the channel.

#### Important information

For partition heights over 4200 mm, use Gypframe Deep Flange Floor & Ceiling Channels.

### Splicing

To extend the studs, overlap by a minimum of 600mm. Use British Gypsum Wafer Head Drywall Screws to fix together. Use two screws per flange. Refer to the construction details in this system.

### Partition to structural steelwork junctions

When designing room layouts, separated by sound insulating walls abutting structural steelwork, consider the potential loss of acoustic performance through the steelwork. If you require a wider partition to fully encompass the steelwork, refer to GypWall Twin Frame Independent or GypWall Twin Frame Braced. Also refer to Building acoustics in system design principles on [british-gypsum.com](http://british-gypsum.com)

### Looking for performance selection tables?

We're committed to providing technical information that is transparent, clear, accurate, and always up-to-date. So you can rely on it when making decisions at any stage of the design, specification, installation, use, maintenance and disposal process.

All performance data is now available to view and download on our website.

[britishgypsum.com/gypwall-resilient](http://britishgypsum.com/gypwall-resilient)



### Door openings

Openings require careful detailing to minimise the loss of acoustic performance through the wall. If in doubt, speak to an Acoustic Consultant. Specialist heavy acoustic doorsets may require additional support. Refer to best practice guidance for openings in fire rated systems document: [british-gypsum.com](http://british-gypsum.com)

### Framing surround for openings

Predetermine the positioning of services to provide a framed opening when required to penetrate the wall e.g. horizontal ducts, fire dampers or access panels. Construct openings using established metal stud procedures. Refer to best practice guidance for openings in fire rated systems document: [british-gypsum.com](http://british-gypsum.com)

### Cavity barriers

Stone mineral wool (by others) cut neatly to fit across the cavity forms a suitable closure.

### Acoustic performance

The partition achieves high levels of sound insulation by separating the board and the stud framing with Gypframe RB1 Resilient Bars. It is important when screw-fixing boards, the screws do not come into contact with the framing. Nor should services and fixtures etc. create a bridge between the lining boards on each side. Seal all air paths to optimise performance. Apply Gyproc Sealant to the perimeter of the inner layer immediately before fitting the face layer board on the side(s) of the partition where Gypframe RB1 Resilient Bars are located.

#### Important note

To achieve the specified performance and to qualify for SpecSure, the system must be specified and finished with either Thistle plaster, ThistlePro plaster or Gyproc jointing products, in accordance with British Gypsum recommendations.

### Deflection heads

Deflection heads may be necessary to accommodate deflections between partitions and the supporting floor. Deflection heads may also be required to the underside of roof structures, which are subject to positive and negative pressures. Partition design can incorporate deflection heads with only a slight reduction in sound insulation performance. Refer to this construction details in this system. To minimise the loss of acoustic performance, refer to Building acoustics in system design principles on [british-gypsum.com](http://british-gypsum.com)

High levels of sound insulation achieved by use of Gypframe RB1 Resilient Bar to separate boards from stud frame

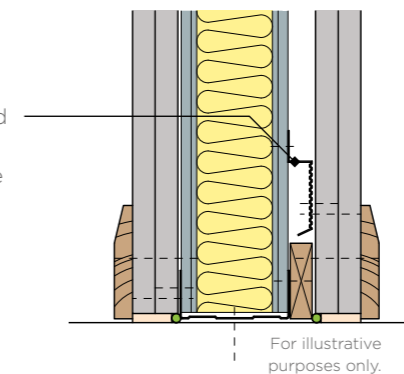

### Services

#### Penetrations

Service penetrations through fire resisting or sound insulating constructions require careful consideration to ensure no loss of performance. Consider the services themselves so they do not act as a mechanism for fire spread or sound transmission. Refer to best practice guidance for openings in fire rated systems document: [british-gypsum.com](http://british-gypsum.com)

### Electrical

Install electrical services in accordance with BS 7671. Use cut-outs in the studs for routing electrical and other small services (refer to this construction details in this system). Support switch boxes and socket outlets by fixing Gypframe 99 FC 50 Fixing Channels horizontally between studs. Use high-performance socket boxes, where acoustic performance is important. Where Gypframe AcouStuds are used, services are routed through 50 mm x 28 mm 'H' shaped push-outs, at the same centres as shown in construction details in internal partitions and walls introduction for conventional cut-outs. Cables should be protected by conduit, or other suitable precautions taken to prevent abrasion when they pass through the metal frame. Service cut-outs should be aligned to allow easy installation of service. If studs need cutting, cut from the same end of each stud to ensure cut-out alignment.

#### Independent support

Consider the size and weight of services, such as fire dampers and ductwork, that will be installed through the partition. Determine whether they can be supported directly by the partition or need independent support, referencing specific manufacturer information/guidance. Refer to this construction details in this system.

### Fixtures

Lightweight fixtures can be installed directly to the partitions. Medium weight fixtures can be made to Gypframe 99 FC 50 Fixing Channel. Heavyweight fixtures to BS 5234, e.g. cupboards, can be fixed using plywood secured with Gypframe Service Support Plates. In all instances, fix these plates to the side without a Gypframe RB1 Resilient Bar. Only install medium and heavyweight fixtures on lining boards that are fixed directly to the stud framing. The installation of fixings may downgrade the acoustic performance of the wall. Refer to Acoustic performance and Service installations in system design principles on [british-gypsum.com](http://british-gypsum.com). Or, where fixtures are required to both sides of a partition, consider using GypWall Twin Frame Independent or GypWall Twin Frame Braced.

### Board finishing

Refer to [british-gypsum.com](http://british-gypsum.com) for our full range and guidance surrounding board finishing products.

### Tiling

Tiles up to 32 kg/m<sup>2</sup> can be fixed directly to the surface of lightweight partition systems. Refer to [british-gypsum.com](http://british-gypsum.com) for our full range and guidance on our tiling-related products.

#### Handy hint

If horizontal board joints are necessary, stagger between layers by a minimum of 600 mm, to avoid downgrading performance. For alternative stud types/sizes, to increase maximum partition height, further options are available. Refer to the White Book Specification Selector on the British Gypsum website.

# GypWall Resilient

## Construction details

### 1. Head and base

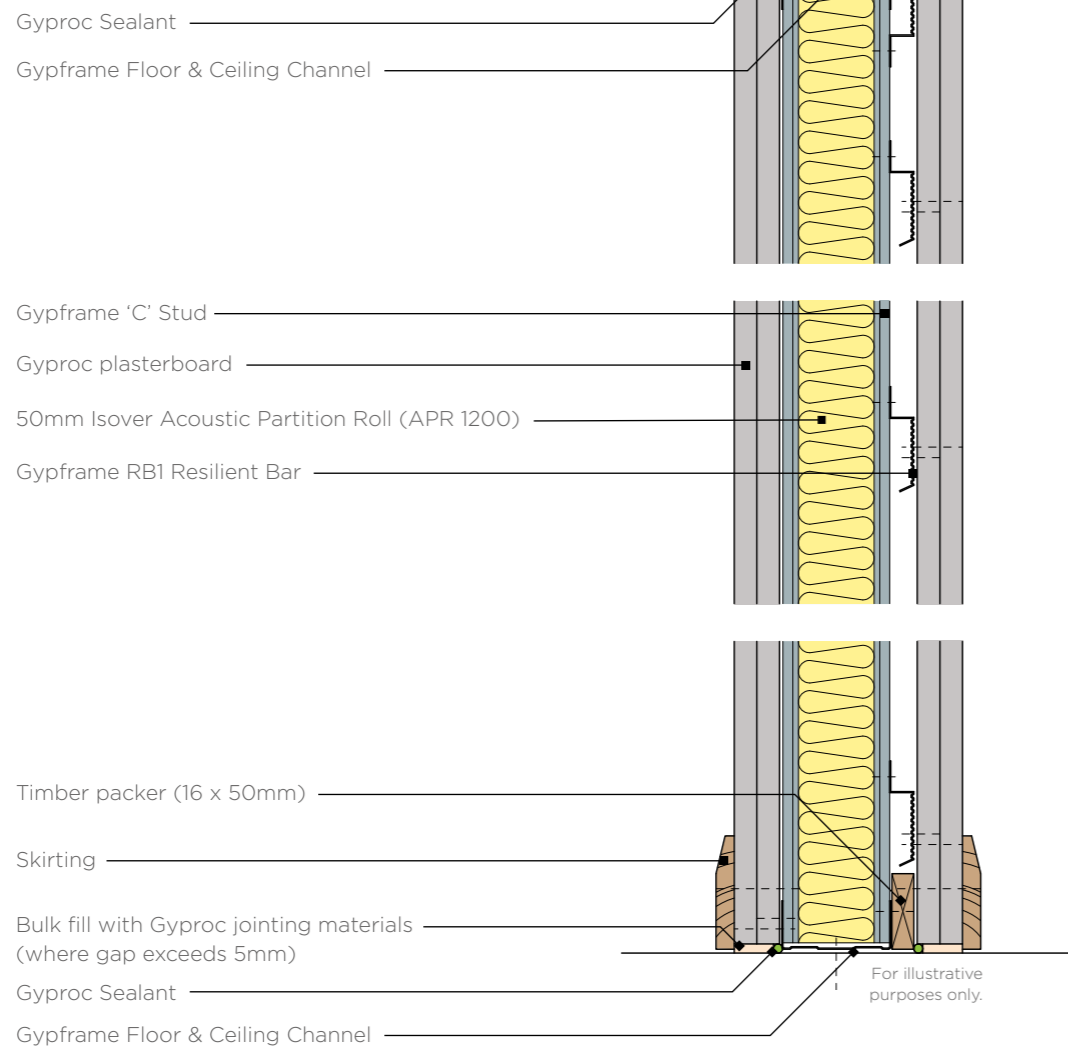

### 2. Junction with masonry

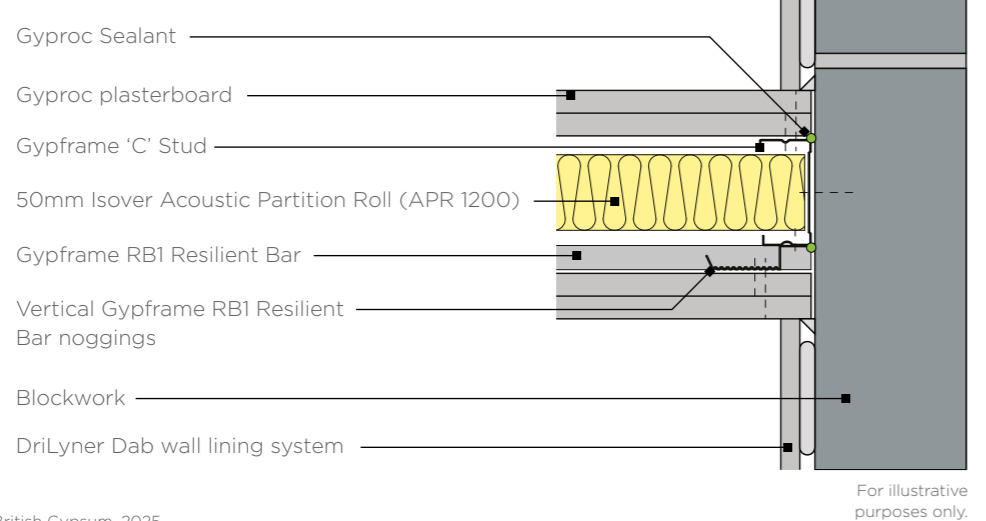

### 3. Deflection head

15mm downward movement and 60 minutes fire resistance

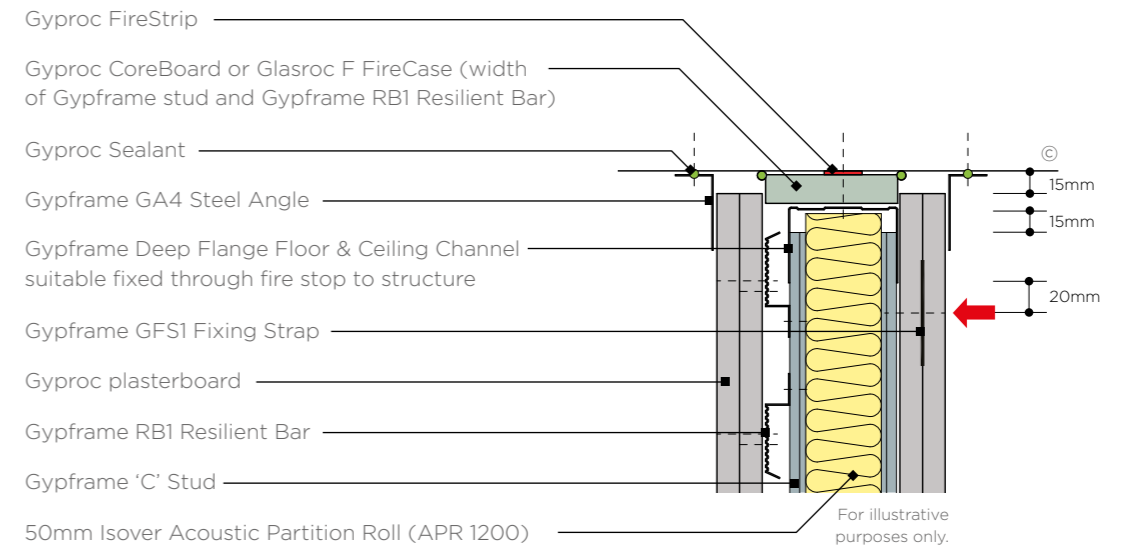

### 4. Corner

Resilient bar to external corner

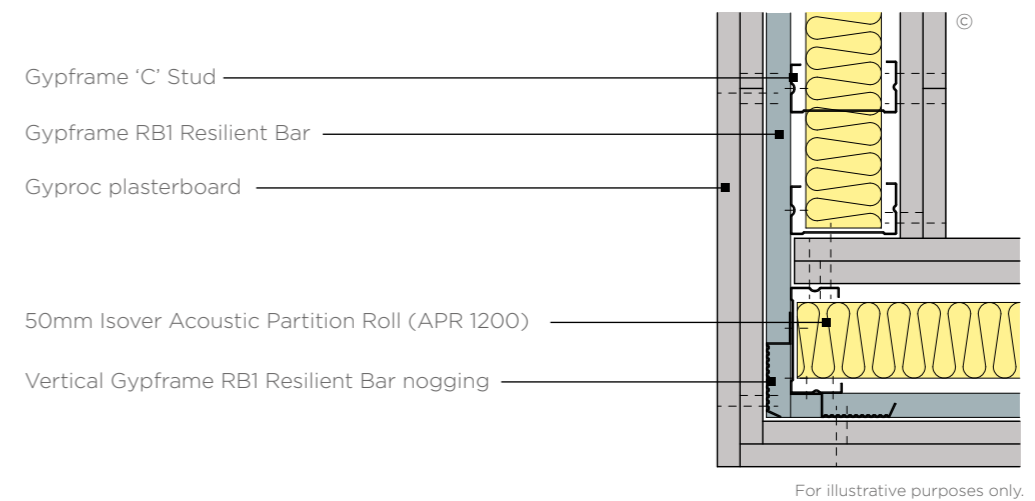

N.B. No fixings should be made through the boards into the flanges of the head channel. The arrow (➡) denotes the position of the uppermost board fixing, which should be made into Gyproframe GFS1 Fixing Strap. Continuous Gyproc FireStrip must be installed as shown to maintain fire performance.

# GypWall Resilient

## Construction details

### 5. Corner

Resilient bar to internal corner

Gypframe RB1 Resilient Bar

Gypframe 'C' Stud

Gyproc plasterboard

Vertical Gypframe RB1 Resilient Bar nogging

50mm Isover Acoustic Partition Roll (APR 1200)

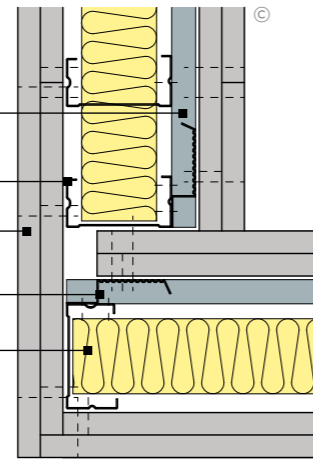

For illustrative purposes only.

### 6. 'T' junction

Resilient bar on opposite side

Gypframe 'C' Stud

Gypframe RB1 Resilient Bar

Gyproc plasterboard

Gypframe GA5 Internal Fixing Angle

50mm Isover Acoustic Partition Roll (APR 1200)

Vertical Gypframe RB1 Resilient Bar nogging

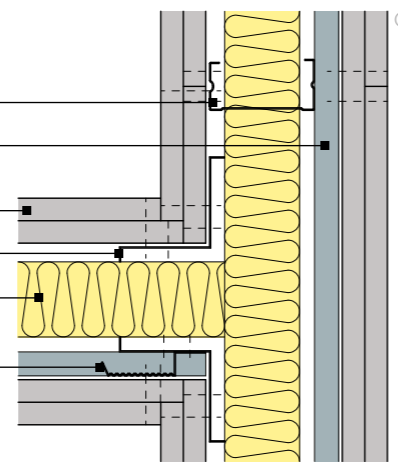

For illustrative purposes only.

### 7. 'T' junction

Resilient bar on abutment side

Gypframe RB1 Resilient Bar

Gypframe 'C' Stud

Gyproc plasterboard

Gypframe GA5 Internal Fixing Angle

50mm Isover Acoustic Partition Roll (APR 1200)

Vertical Gypframe RB1 Resilient Bar nogging

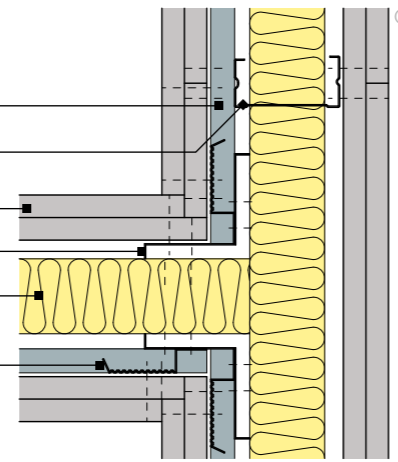

For illustrative purposes only.

### 8. Door frame to satisfy BS 5234: Parts 1 and 2: 1992

Heavy and Severe Duty (up to 60kg door)

Gypframe 'C' Stud to maintain stud module

Gypframe Folded Edge Standard Floor & Ceiling Channel cut and bent to form door head

Gypframe Folded Edge Standard Floor & Ceiling Channel

Gypframe RB1 Resilient Bar vertical nogging

Gypframe RB1 Resilient Bar

Gypframe 'C' Stud

Gypframe Floor & Ceiling Channel

Gypframe Folded Edge Standard Floor & Ceiling Channel cut and extends up studs

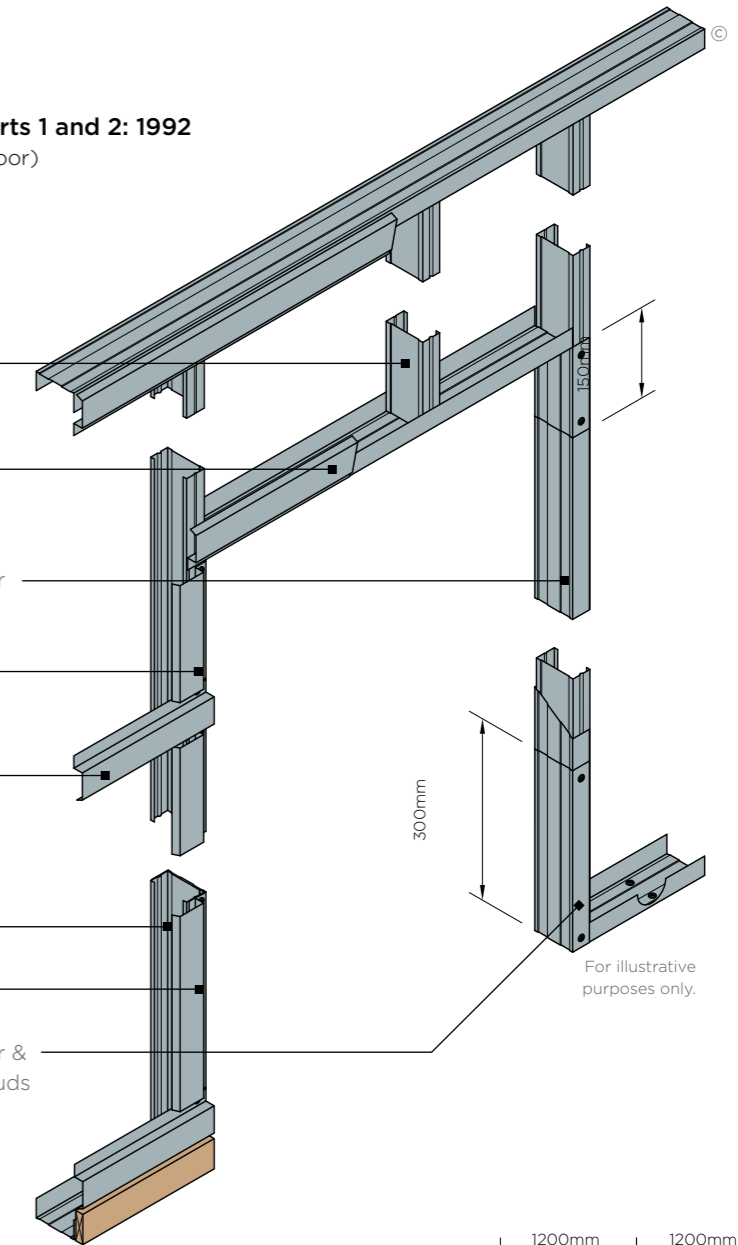

For illustrative purposes only.

Gyproc plasterboard

Timber door frame and architrave

50mm Isover Acoustic Partition Roll (APR 1200)

Suitable solvent based construction adhesive with instant grab (by others)

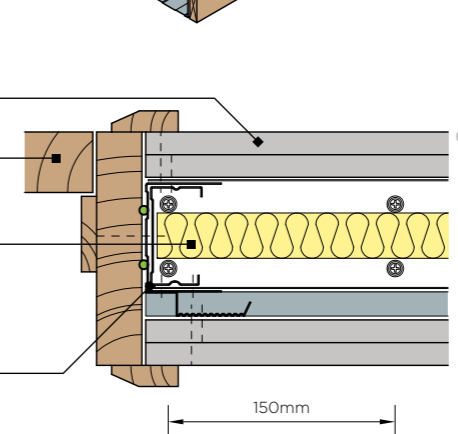

For illustrative purposes only.

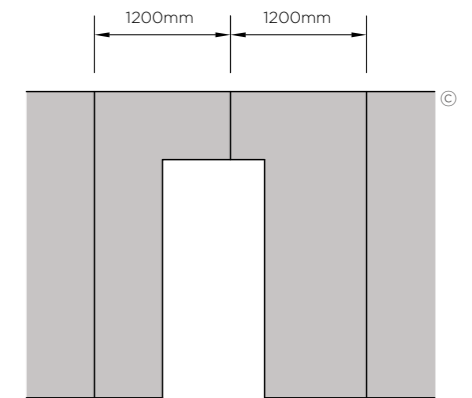

For illustrative purposes only.

Note: Advice should be sought from the door manufacturer before the construction of these details.

# GypWall Resilient

## System components

Improve the acoustic performance of your partitions and separating walls with minimal loss of floor space.

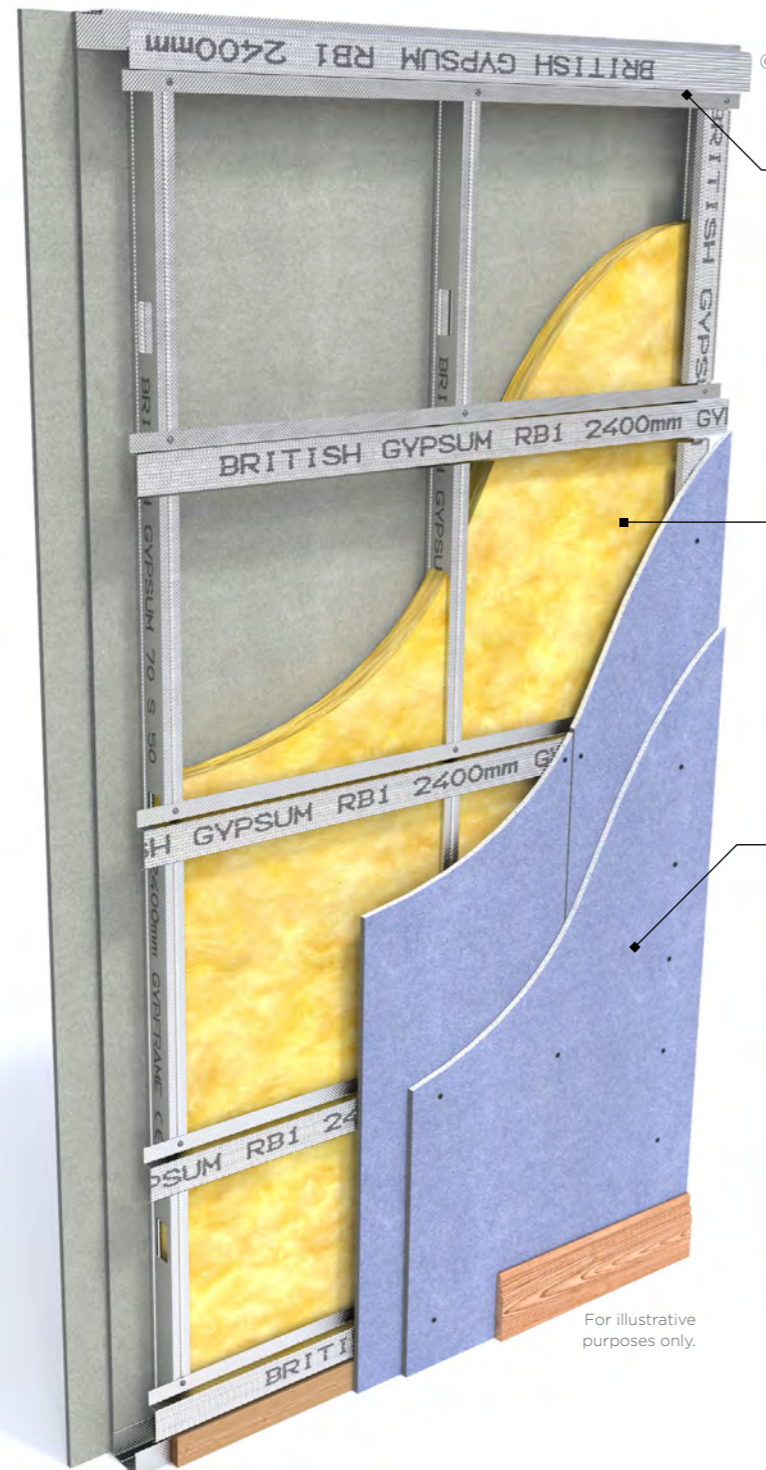

**Gypframe RB1 Resilient Bar**  
A specially engineered product providing optimum acoustic performance. In wall and ceiling systems, Gypframe RB1 Resilient Bars are used in conjunction with metal studs (GypWall Resilient) or timber studs/ joists to reduce sound transmission.



**Isover Acoustic Partition Roll**  
Glass mineral wool for enhanced acoustic and thermal performance.

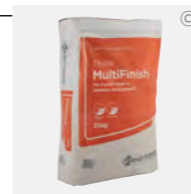

**Finishes**  
Additional acoustic performance can be achieved with application of Thistle MultiFinish plaster skim on selected specifications.

For illustrative purposes only.



There are specifications within this system that qualify for our **SpecSure** warranty. For more information, contact us through [british-gypsum.com](http://british-gypsum.com)

© British Gypsum, 2025.

© British Gypsum, 2025.

Careful product choice is central to maintaining system integrity, performance requirements and eligibility for our **SpecSure** warranty. **Ensure an optimum standard of build by considering...**

### What are you fixing?

Our market leading range of plasterboard linings for walls, ceilings, floors, partitions and encasements for any building type. See [british-gypsum.com](http://british-gypsum.com) for more details.

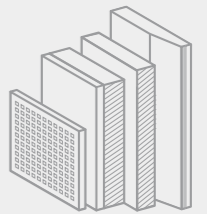

### What are you fixing to?

Our Gypframe metal profiles provide a strong and versatile structure for fixing our partition lining, floor and ceiling systems. See [british-gypsum.com](http://british-gypsum.com) for more details.

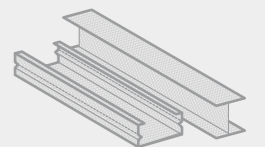

### What are you fixing with?

Our fixings offer guaranteed compatibility with our systems, and are rigorously tested to meet the highest quality standards. See [british-gypsum.com](http://british-gypsum.com) for more details.

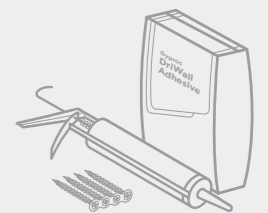

### What are you finishing with?

#### Plaster

Our wide range of Thistle plasters and Thistle accessories give you everything you need to finish a job to the highest possible standard. See [british-gypsum.com](http://british-gypsum.com) for more details.



#### Finishing products

Our Gyproc jointing range gives you everything you need to complete a wall lining, partition or ceiling system, whatever the size and complexity of the project. See [british-gypsum.com](http://british-gypsum.com) for more details.

**Where defined performance requirements are required see our White Book Specification Selector on [british-gypsum.com](http://british-gypsum.com)**

# GypWall Resilient Installation

The information below is intended to be a basic description of how the system is built.



**1** Suitably fix the appropriate Gypframe Floor & Ceiling Channels to the floor and soffit at the required centres.

Important note - if you are using Gypframe RB1 Resilient Bars on one side of the partition only, the dimensions will be offset by 16mm. Consider this when detailing to show locations of partition layouts. For deflection heads see suitable details.



**2** Fix Gypframe 'C' Studs to abutments and openings using suitable fixings.



**7** Where Gypframe RB1 Resilient Bars are fixed transverse at the lowest point on the partition, a timber nogging should be suitably fixed beneath the Gypframe RB1 Resilient Bars to stop it being trapped when skirting is installed.



**8** Add Isover Acoustic Partition Roll (APR 1200) insulation to the partition cavity for optimal acoustic performance.



**3** Friction fit Gypframe 'C' studs into the appropriate Gypframe Channels at required centres.

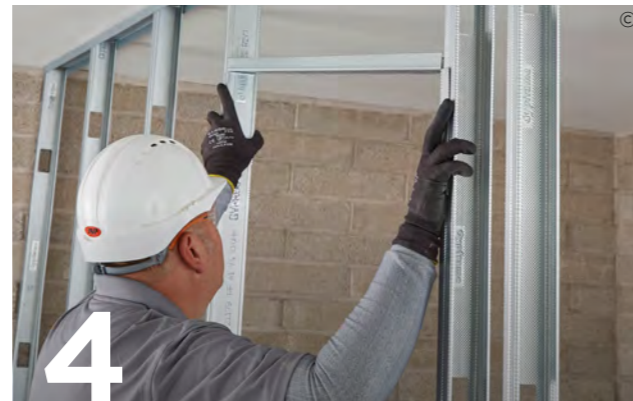

**4** Construct door openings to suit the partitions' duty rating.

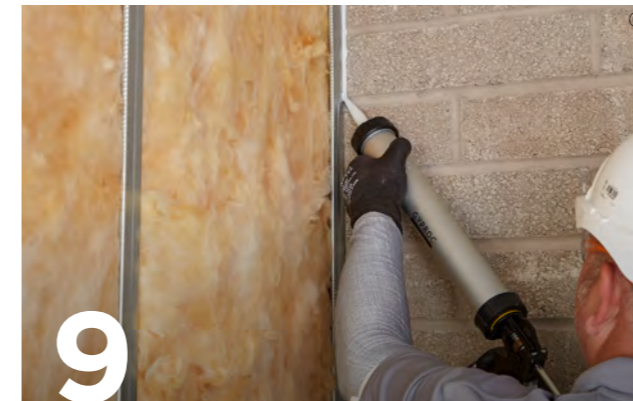

**9** Use Gyproc Sealant to seal the perimeter of the partition except on the side where Gypframe RB1 Resilient Bars are to be installed. Where Gypframe RB1 Resilient Bars are to be installed, the Gyproc Sealant is applied to the perimeter of the first layer of board.



**10** Use British Gypsum Drywall Screws to fix Gyproc plasterboards to the Gypframe RB1 Resilient Bars, with all joints staggered.

Important note - To maintain acoustic performance, care must be taken to select the correct length screws to avoid them contacting or penetrating the Gypframe 'C' Studs when fixing Gyproc plasterboards to Gypframe RB1 Resilient Bar.

Important note - Where Gyproc Plank is required as an inner layer, it is fixed horizontally to the Gypframe RB1 Resilient Bars at each bar position.



**5** Transverse fix Gypframe RB1 Resilient Bars to the stud framing. Join Gypframe RB1 Resilient Bars by nesting them together over a Gypframe 'C' Stud using British Gypsum Wafer Head Drywall Screws.

Important note - Gypframe RB1 Resilient Bars are normally fixed with the base flange on the top side, with the exception of the uppermost bar, which is fixed base flange down to provide board fixing at the head.



**6** Install Gypframe RB1 Resilient Bars vertically to abutment and door studs to accept perimeter fixings for the Gyproc plasterboard linings.

© British Gypsum, 2025.

© British Gypsum, 2025.