

Insulation

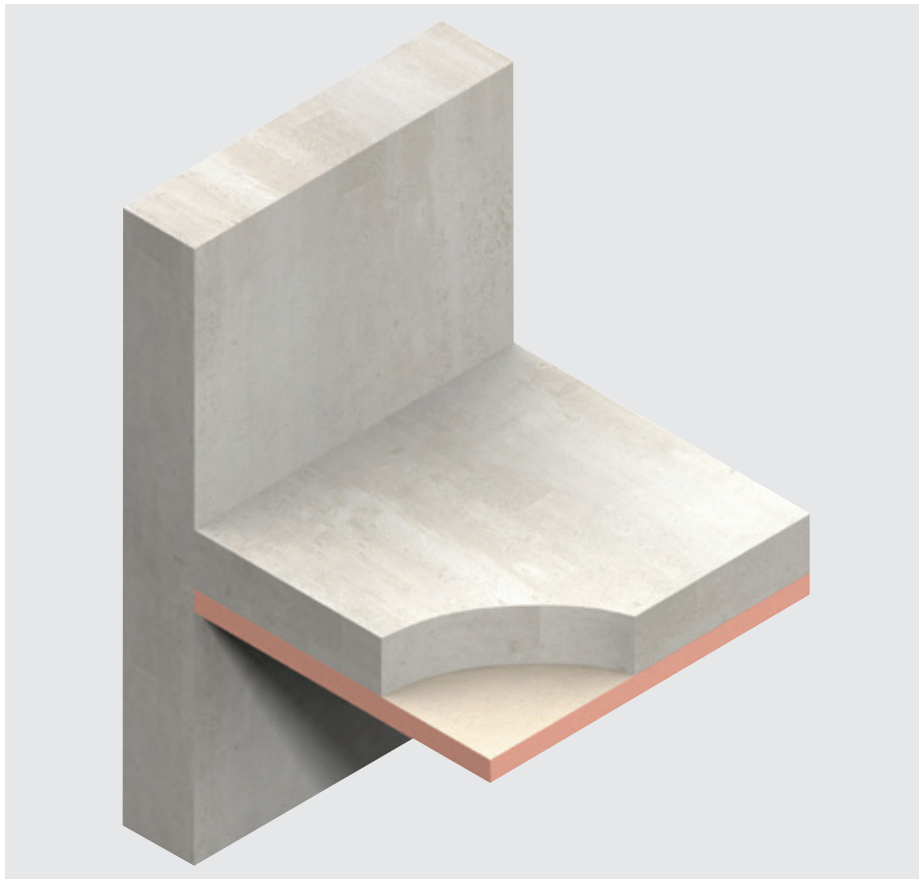

Kooltherm® K110 Soffit Board

Insulation for Structural Ceilings (Soffits)



- Premium performance rigid thermoset phenolic insulation - thermal conductivity of 0.018 W/mK
- For FM approval, see page 8
- Unaffected by air infiltration
- Resistant to the passage of water vapour
- Easy to handle
- Quick to install
- Ideal for new build and refurbishment
- Non-deleterious material
- Manufactured with a blowing agent that has zero ODP and low GWP

Fibre-free
Core



Kingspan®

Typical Constructions and U-values

Assumptions

The U-values in Table 1 have been calculated, under a management system certified to the BBA Scheme for Assessing the Competency of Persons to Undertake U-value and Condensation Risk Calculations, using the method detailed in BS EN ISO 6946: 2017 / I.S. EN ISO 6946: 2007 (Building components & building elements. Thermal resistance & thermal transmittance. Calculation methods), and using the conventions set out in BR 443 (Conventions for U-value calculations). They are valid for the construction shown in Figure 1.



These examples are based on the use of Kingspan Kooltherm® K110 mechanically fixed directly to the soffit of a 200 mm concrete deck using thermally broken fasteners with a thermal conductivity of 1.00 W/mK or less, the effect of which is insignificant.

NB When calculating U-values to BS EN ISO 6946: 2017 / I.S. EN ISO 6946: 2007, the type of fixing used may change the thickness of insulation required. If metal fixings are to be used, contact the Kingspan Insulation Technical Service Department for a comprehensive U-value calculation, which will take account of the correction factor specific to the fixing.

NB For the purposes of these calculations the standard of workmanship has been assumed good, and therefore the correction factor for air gaps has been ignored.

NB The figures quoted are for guidance only. A detailed U-value calculation and a condensation risk analysis should be completed for each project.

NB If your construction is different from those specified, and / or to gain a comprehensive U-value calculation along with a condensation risk analysis of your project, contact the Kingspan Insulation Technical Service Department for assistance.

NB There are restrictions placed upon this product which vary dependant on product location within the building and project location. For guidance regarding the routes to compliance for meeting the fire safety requirements of the Building Regulations / Standards, refer to the relevant Technical Bulletins and links to Government websites at www.kingspaninsulation.co.uk/fireregulations

U-value Table Key

Where an **X** is shown, the U-value is higher than the worst of the maximum new build area weighted average U-values allowed by the:

- 2013 editions of Approved Documents L to the Building Regulations for England;
- 2014 editions of Approved Documents L to the Building Regulations for Wales;
- 2019 editions of Technical Handbooks Section 6 to the Building Standards for Scotland;
- 2012 editions of Technical Booklets F1 & F2 to the Building Regulations for Northern Ireland; and
- 2011 edition of Technical Guidance Document L (Dwellings) and 2008 edition of Technical Guidance Document L (Buildings other than Dwellings) to the Building Regulations for the Republic of Ireland.

Fixed Directly to Concrete Soffit

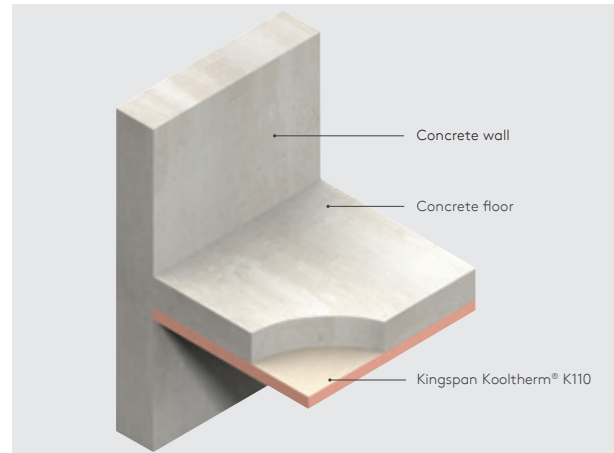

Figure 1

Insulant Thickness (mm)	U-values (W/m ² K)
60	X
65	0.25
70	0.24
75	0.22
80	0.21
85	0.20
90	0.19
100	0.17
110	0.15
120	0.14
60 + 70	0.13
70 + 70	0.12
80 + 80	0.11
90 + 90	0.10
100 + 100	0.09

NB Refer to local distributor or Kingspan Insulation price list for current stock and non-stock sizes.

Design Considerations

Heat Loss and Linear Thermal Bridging

Basic Principles

Linear thermal bridging describes the additional heat losses or gains that occur at junctions between elements e.g. where a cavity wall meets the ground or intermediate floor, or at junctions around openings in the building fabric where the thermal insulation layer is discontinuous e.g. sills, jambs and lintels.

Interruptions within the insulation layer by materials with poorer insulating properties can result in a thermal bridge, which in turn can lead to problems of internal surface condensation and mould growth, especially if there is a drop in surface temperature.

The heat flow at these junctions and opening locations, over and above that through the adjoining plane elements, is the linear thermal transmittance of the thermal bridge: measured in W/mK; referred to as a 'psi-value'; and expressed as a 'ψ-value'.

The lower the ψ-value, the better the performance. ψ-values are taken into account in the calculation methodologies e.g. the Standard Assessment Procedure (SAP) that are used to assess the operational CO₂ emissions and, where applicable, the fabric energy efficiency of buildings.

ψ-values can comprise either, or a combination of, approved, calculated or assumed values.

Approved details, such as the Accredited Construction Details (England & Wales / Scotland / Northern Ireland) and Acceptable Construction Details (Republic of Ireland), collectively referred to here as ACDs, can uplift performance to provide a clear starting point towards achieving compliance, but they are limited in scope and applicability. The greatest opportunity for mitigating the impact of linear thermal bridges can come from following accurately 'modelled' details that take into account the following design considerations.

Reducing Linear Thermal Bridging

For soffit constructions, supporting beams and columns interrupting the insulation layer can represent significant thermal bridges, which can adversely affect the thermal performance of the floor if not suitably handled. Thermally, the best approach is to fully box around beams with appropriate insulation to limit these losses. For further advice on reducing linear and point thermal bridging, please contact Kingspan Insulation's Technical Service Department (see rear cover for details).

Responsible Sourcing

Kingspan Kooltherm® K110 produced at Kingspan Insulation's Pembridge, Herefordshire manufacturing facility is certified to BES 6001 (Framework Standard for the Responsible Sourcing of Construction Products) 'Excellent'.



NB The above information is correct at the time of writing. Confirm at the point of need by contacting Kingspan Insulation's Technical Service Department (see rear cover for details) from which a copy of Kingspan Insulation's BES 6001 certificate can be obtained.

Sustainability & Responsibility

Kingspan Insulation has a long-term commitment to sustainability and responsibility: as a manufacturer and supplier of insulation products; as an employer; as a substantial landholder; and as a key member of its neighbouring communities.

A report covering the sustainability and responsibility of Kingspan Insulation Ltd's British operations at its Pembridge, Herefordshire and Selby, North Yorkshire manufacturing facilities is available at www.kingspaninsulation.co.uk/sustainabilityandresponsibility.

Design Considerations

Specification Clause

Kingspan Kooltherm® K110 should be described in specifications as:

The soffit insulation shall be Kingspan Kooltherm® K110 _____ mm thick: comprising a premium performance fibre-free rigid thermoset phenolic insulation core with a glass tissue based facing on its inner face and a low emissivity composite foil on its outer face. The product shall have a thermal conductivity of 0.018 W/mK. The product shall be manufactured: with a blowing agent that has zero Ozone Depletion Potential (ODP) and low Global Warming Potential (GWP); under a management system certified to ISO 9001: 2015, ISO 14001: 2015, BS OHSAS 18001: 2007 and ISO 50001: 2011; by Kingspan Insulation Limited; and installed in accordance with the instructions issued by them.

NBS Specifications

Details also available in NBS Plus.
NBS users should refer to clause(s):
E60-110, 130 and 140 (Standard)



Building Information Modelling (BIM)

Kingspan Insulation's BIM objects can be downloaded in Revit and in IFC formats. For more information please visit www.kingspaninsulation.co.uk/bim.

Kingspan Kooltherm® K110 is also available as part of various system families for typical construction build-ups, to be used within a Building Information Model. To download the objects, please visit www.uvalue-calculator.co.uk.

Wind Loading

Where the insulation boards may be subject to external wind pressure, wind loadings should be assessed in accordance with BS / I.S. EN 1991-1-4: 2005 + A1: 2010 (National Annex to Eurocode 1 Actions on Structures. General Actions. Wind Actions) taking into account:

- length / width / height of the building;
- orientation of the building;
- wind speed;
- aspect (i.e. on a hill side); and
- topographical value of the surrounding area.

Lightning Protection

Building designers should give consideration to the requirements of BS / I.S. EN 62305: 2011 (Protection against lightning).

Sitework

Fixing Directly to Concrete Soffits

The installation guidance for Kingspan Kooltherm® K110 outlined in this section must only be followed after considering the below.

There are restrictions placed upon this product which vary dependant on product location within the building and project location. For guidance regarding the routes to compliance for meeting the fire safety requirements of the Building Regulations / Standards, refer to the relevant Technical Bulletins and links to Government websites at www.kingspaninsulation.co.uk/fireregulations

- Insulation boards should be installed break-bonded, with joints lightly butted.
- The number of mechanical fixings required to fix Kingspan Kooltherm® K110 will vary with the geographical location of the building, the local topography, the height and width of the soffit concerned, and the soffit construction.
- A minimum of 11 mechanical fixings, with a minimum head diameter of 25 mm, are required to secure the insulation board to the soffit.
- Where the insulation boards may be subject to external wind pressure, the requirement for additional fixings should be assessed in accordance with BS / I.S. EN 1991-1-4: 2005 + A1: 2010 (National Annex to Eurocode 1 Actions on Structures. General Actions. Wind Actions).
- The fixings should be evenly distributed over the whole area of the board, and must offer a minimum 40 mm penetration into a solid substrate.
- Please refer to the column opposite for recommended fixing patterns.
- Fixings at board edges must be located > 50 mm and < 150 mm from edges and corners of the board and not overlap board joints.
- Depending upon the fixing type, insulation boards can also be fitted by a shot fired fixing method, which can result in significantly faster installation times. All of the guidance above still applies.
- For details on fixings refer to:

Ejot UK Limited +44 (0) 1977 687 040
www.ejot.co.uk

Fixfast +44 (0) 1732 882 387
www.fixfast.com

ITW Spit +44 (0) 800 731 4924
www.itwcp.co.uk/Spit/

MAK Fasteners +353 (0) 1 451 9004
www.makfasteners.com

Masonry Fixings Services Ltd +353 (0) 1 642 6700
www.masonryfixings.ie

SFS Intec +44 (0) 1132 085 500
www.sfsintec.biz/uk

Recommended Fixing Patterns

- The images below show recommended fixing patterns, the number of fixings used and the resultant fixing density (number of fixings per m²).
- The fixing patterns shown are suitable for continuous flat (even) decks only. For non-continuous decks please contact the Kingspan Insulation Technical Service Department (see rear cover) for further guidance.

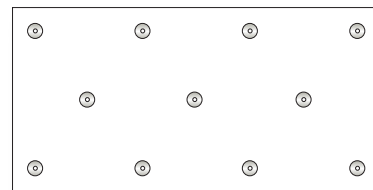

11 No. per board
(2.4 x 1.2 m board - 3.81 fixings / m²)

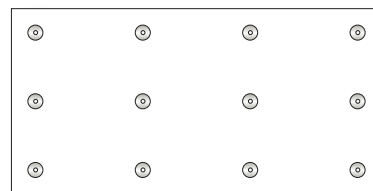

12 No. per board
(2.4 x 1.2 m board - 4.16 fixings / m²)

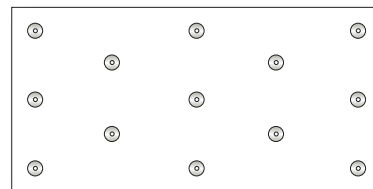

13 No. per board
(2.4 x 1.2 m board - 4.51 fixings / m²)

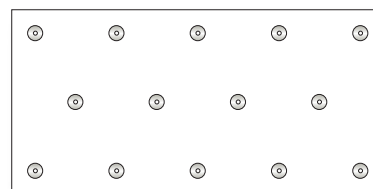

14 No. per board
(2.4 x 1.2 m board - 4.86 fixings / m²)

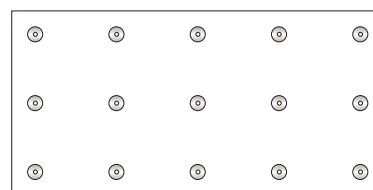

15 No. per board
(2.4 x 1.2 m board - 5.20 fixings / m²)

Proprietary Grid Systems

- Kingspan Kooltherm® K110 can also be fixed to a proprietary grid system comprising metal furring bars or timber battens.
- For further information regarding proprietary grid system specifications, please contact the Kingspan Insulation Technical Service Department (see rear cover).

Taping

- The joints of Kingspan Kooltherm® K110 should always be taped using a suitable 75 mm min. wide self-adhesive aluminium foil tape.
- In the absence of other protection, exposed edges of Kingspan Kooltherm® K110 should be protected by a suitable self-adhesive aluminium foil tape, with a 50 mm min. wide overlap onto the insulation board face (Figure 2).
- For advice on the specification of self-adhesive aluminium foil tape and application guidelines, refer to:

Bostik Limited
www.bostik.co.uk

+44 (0) 1785 272 727

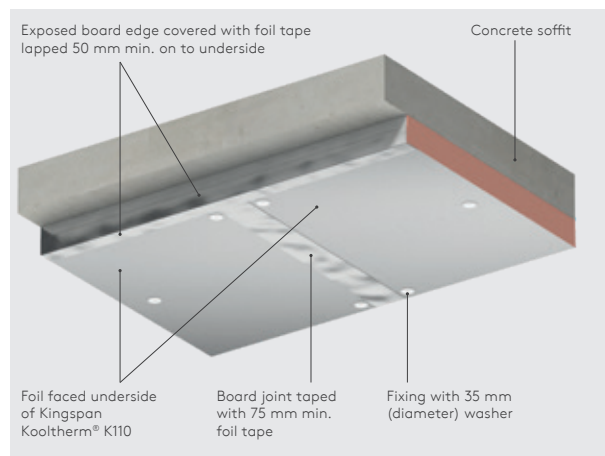

Figure 2 - Protection of Exposed Insulation Edges of Kingspan Kooltherm® K110

General

Cutting

- Cutting should be carried out either by using a fine toothed saw or scoring with a sharp knife, snapping the board over a straight edge and then cutting the facing on the other side.
- Ensure accurate trimming to achieve close-butting joints and continuity of insulation.

Availability

- Kingspan Kooltherm® K110 is available through specialist insulation distributors and selected builders' merchants throughout the UK and Ireland.

Packaging & Storage

- The polyethylene packaging of Kingspan Insulation products, which is recyclable, should not be considered adequate for outdoor protection.
- Ideally, boards should be stored inside a building. If, however, outside storage cannot be avoided, then the boards should be stacked clear of the ground and covered with an opaque polythene sheet or weatherproof tarpaulin. Boards that have been allowed to get wet should not be used.

Health & Safety

- Kingspan Insulation products are chemically inert and safe to use.
- A Safety Information Data Sheet for this product is available from the Kingspan Insulation website www.kingspaninsulation.co.uk/safety or www.kingspaninsulation.ie/safety.

Please note that the reflective surfaces on this product are designed to enhance its thermal performance. As such, they will reflect light as well as heat, including ultraviolet light. Therefore, if this product is being installed during very bright or sunny weather, it is advisable to wear UV protective sunglasses or goggles, and if the skin is exposed for a significant period of time, to protect the bare skin with a UV block sun cream.

The reflective facings used on this product can be slippery when wet. Therefore, it is recommended that any excess material should be contained to avoid a slip hazard.

Warning - do not stand on or otherwise support your weight on this product unless it is fully supported by a load bearing surface.

Product Details

The Inner Facing

The inner (concealed) facing of Kingspan Kooltherm® K110 is a glass tissue based facing, autohesively bonded to the insulation core during manufacture.

The Core

The core of Kingspan Kooltherm® K110 is a premium performance rigid thermoset fibre-free phenolic insulant manufactured with a blowing agent that has zero Ozone Depletion Potential (ODP) and low Global Warming Potential (GWP).



The Outer Facing

The outer (exposed) facing of Kingspan Kooltherm® K110 is a low emissivity composite foil, autohesively bonded to the insulation core during manufacture. The exposed facing used on Kingspan Kooltherm® K110 has not been designed with the purpose of an aesthetic finish as its primary function. Where appearance is critical, advice should be sought from Kingspan Insulation's Technical Service Department (see rear cover).

Standards & Approvals

Kingspan Kooltherm® K110 is manufactured to the highest standards under a management system certified to ISO 9001: 2015 (Quality Management Systems. Requirements), ISO 14001: 2015 (Environmental Management Systems. Requirements), BS / I.S. OHSAS 18001: 2007 (Occupational Health & Safety Management Systems. Requirements) and ISO 50001: 2011 (Energy Management Systems. Requirements with guidance for use).

The use of Kingspan Kooltherm® K110 is covered by BBA Certificate 16/5299 and by LABC Registered Details Certificate No. EWWS545F2.



Standard Dimensions

Kingspan Kooltherm® K110 is available in the following standard size:

Nominal Dimension		Availability
Length	(m)	2.4
Width	(m)	1.2
Insulant Thickness	(mm)	Refer to local distributor or Kingspan Insulation price list for current stock and non-stock sizes.

Compressive Strength

The compressive strength of Kingspan Kooltherm® K110 typically exceeds 100 kPa, when tested to BS / I.S. EN 826: 2013 (Thermal insulating products for building applications. Determination of compression behaviour).

Water Vapour Resistance

Adjusted for the effect of board joints, the product typically achieves a resistance far greater than 41.6 MN.s/g, when tested in accordance with BS / I.S. EN 12086: 2013 (Thermal insulating products for building applications. Determination of water vapour transmission properties).

Durability

If correctly installed, Kingspan Kooltherm® K110 can have an indefinite life. Its durability depends on the supporting structure and the conditions of its use.

NB If the building is considered to be in an exposed location advice should be sought from the Kingspan Insulation Technical Service Department to determine the product's suitability.

Resistance to Solvents, Fungi & Rodents

The insulation core is resistant to short-term contact with petrol and with most dilute acids, alkalis and mineral oils. However, it is recommended that any spills be cleaned off fully before the boards are installed. Ensure that safe methods of cleaning are used, as recommended by suppliers of the spilt liquid. The insulation core is not resistant to some solvent-based adhesive systems, particularly those containing methyl ethyl ketone. Adhesives containing such solvents should not be used in association with this product. Damaged boards or boards that have been in contact with harsh solvents or acids should not be used.

The insulation core and facings used in the manufacture of Kingspan Kooltherm® K110 resist attack by mould and microbial growth, and do not provide any food value to vermin.

Product Details

FM Approval

Kingspan Kooltherm® K110 is FM Approved to FM 4880 (Approval Standard for Class 1 Fire Rating of Building Panels or Interior Finish Materials) October 2015. Kooltherm® K110 (thicknesses up to, and including, 120 mm) produced at Kingspan Insulation's Pembridge, Herefordshire manufacturing facility is FM Approved. This approval is valid for ceiling / soffit insulation only, with non-combustible walls with no height restriction. For the purpose of FM Approval, the Kooltherm® K110 entire product thickness and exposed facer should be fastened to the supporting structural soffit with metal mechanical fasteners & washer plates with minimum 50 mm wide aluminium tape over joints. For mechanical reasons the fixing specification given on page 4 of this document and the taping specification on page 5 must still be followed.



Not all thicknesses and roof deck constructions are covered by the FM Approval. Further details of the current FM Approval can be located on the FM Approvals online listing website 'Approval Guide' at www.fmapprovals.com/approval-guide or www.approvalguide.com by searching 'Kooltherm K110' or alternatively contact the Kingspan Insulation Technical Service Department (see rear cover).

Fire Performance

There are restrictions placed upon this product which vary dependant on product location within the building and project location. For guidance regarding the routes to compliance for meeting the fire safety requirements of the Building Regulations / Standards, refer to the relevant Technical Bulletins and links to Government websites at www.kingspaninsulation.co.uk/fireregulations

Kingspan Kooltherm® K110 achieves European Classification (Euroclass) C-s1,d0, when the outer (exposed) composite foil facing is exposed to the heat source, when classified to EN 13501-1:2018 (Fire classification of construction products and building elements. Classification using data from reaction to fire tests).

Further details on the fire performance of Kingspan Insulation products may be obtained from Kingspan Insulation's Technical Service Department (see rear cover).

Thermal Properties

The λ -values and R-values detailed below are quoted in accordance with BS EN 13166: 2012 + A2: 2016 (Thermal insulation products for buildings. Factory made phenolic foam (PF) products. Specification).

Thermal Conductivity

The boards achieve a thermal conductivity (λ -value) of 0.018 W/mK.

Thermal Resistance

Thermal resistance (R-value) varies with thickness and is calculated by dividing the thickness of the board (expressed in metres) by its thermal conductivity. The resulting number is rounded down to the nearest 0.05 (m²K/W).

Insulant Thickness (mm)	Thermal Resistance (m ² K/W)
60	3.30
65	3.60
70	3.85
75	4.15
80	4.40
85	4.70
90	5.00
100	5.55
110	6.10
120	6.65
130	7.20
140	7.75
160	8.85
180	10.00
200	11.10

NB Kingspan Insulation's maximum available single insulation thickness is subject to alteration without notice. At the time of publication, this specific insulation thickness must be built up from two thinner layers, but this may have changed by the time that the information in this literature is relied upon. Please contact Kingspan Insulation's Technical Service Department (see rear cover) for current stock and non-stock sizes. Where multiple layers of insulation of different thicknesses are used, the thickest layer should be installed as the outermost layer in the construction.

Kingspan Insulation

Company Details

Kingspan Insulation Ltd is part of the Kingspan Group plc., one of Europe's leading construction product manufacturers. The Kingspan Group was formed in the late 1960s and is a publicly quoted group of companies headquartered in Kingscourt, County Cavan, Ireland.

Kingspan Insulation Ltd is a market leading manufacturer of premium and high performance rigid insulation products and insulated systems for building fabric and building services applications.

Products & Applications

Kingspan Insulation Ltd has a vast product range. Kingspan Insulation Ltd products are suitable for both new build and refurbishment in a variety of applications within both domestic and non-domestic buildings. The available insulation solutions are listed below.

- Pitched Roofs
- Flat Roofs
- Green Roofs
- Cavity Walls
- Solid Walls
- Timber and Steel Framing
- Insulated Cladding Systems
- Insulated Render Systems
- Floors
- Soffits
- Ductwork

Further Solutions:

- Insulated Dry-Lining
- Tapered Roofing Systems
- Cavity Closers
- The Kingspan KoolDuct® System
- Kingspan nilvent®
- Kingspan TEK® Building System

Insulation Product Benefits

Kingspan OPTIM-R® Vacuum Insulation Panel (VIP) Products

- With a declared value thermal conductivity of 0.007 W/mK, these products provide an insulating performance that is up to five times better than commonly used insulation materials.
- Provides high levels of thermal efficiency with minimal thickness.
- Over 90% (by weight) recyclable.

Kingspan Kooltherm® and Kooltherm® 100 Products

- With a thermal conductivity of 0.018–0.023 W/mK these are the most thermally efficient insulation products commonly used.
- The thinnest commonly used insulation products for any specific U-value.
- Manufactured with a blowing agent that has zero Ozone Depletion Potential (ODP) and low Global Warming Potential (GWP).

Kingspan QuadCore®

- With a thermal conductivity of 0.021 W/mK this is amongst one of the more thermally efficient insulation products commonly used.
- Offering excellent thermal and fire performance, enhanced environmental credentials and backed by an extended warranty.
- Manufactured with a blowing agent that has zero Ozone Depletion Potential (ODP) and low Global Warming Potential (GWP).

Kingspan Therma™ Products

- With a thermal conductivity of 0.022–0.028 W/mK these are amongst the more thermally efficient insulation products commonly used.
- Manufactured with a blowing agent that has zero Ozone Depletion Potential (ODP) and low Global Warming Potential (GWP).

Kingspan GreenGuard® Products

- Rigid extruded polystyrene insulation (XPS) has the necessary compressive strength to make it the product of choice for specialist applications such as heavy duty flooring, car park decks and inverted roofing.
- Manufactured with a blowing agent that has zero Ozone Depletion Potential (ODP) and low Global Warming Potential (GWP).

All Products

- Unaffected by air infiltration - a problem that can be experienced with mineral fibre and which can reduce thermal performance.
- Safe and easy to install.
- If installed correctly, can provide reliable long term thermal performance over the lifetime of the building.
- Each product achieves the required fire performance for its intended application.

Contact Details

UK

Kingspan Insulation Ltd
Pembroke | Leominster
Herefordshire | HR6 9LA

T: +44 (0) 1544 388 601

F: +44 (0) 1544 388 888

E: info@kingspaninsulation.co.uk

www.kingspaninsulation.co.uk

For individual department contact details please visit

www.kingspaninsulation.co.uk/contact

Ireland

Kingspan Insulation Ltd
Castleblayney | County Monaghan

T: +353 (0) 42 979 5000

F: +353 (0) 42 975 4299

E: info@kingspaninsulation.ie

www.kingspaninsulation.ie

For individual department contact details please visit

www.kingspaninsulation.ie/contact

Kingspan Insulation Ltd reserves the right to amend product specifications without prior notice. Product thicknesses shown in this document should not be taken as being available ex-stock and reference should be made to the current Kingspan Insulation price-list or advice sought from Kingspan Insulation's Customer Service Department. The information, technical details and fixing instructions etc. included in this literature are given in good faith and apply to uses described. Recommendations for use should be verified for suitability and compliance with actual requirements, specifications and any applicable laws and regulations. For other applications or conditions of use, Kingspan Insulation offers a Technical Advisory Service, the advice of which should be sought for uses of Kingspan Insulation products that are not specifically described herein. Please check that your copy of this literature is current by contacting the Kingspan Insulation Marketing Department.

© Kingspan, Kingspan GreenGuard, KoolDuct, Kooltherm, nilvent, OPTIM-R, QuadCore, TEK and the Lion Device are Registered Trademarks of the Kingspan Group plc in the UK, Ireland and other countries. All rights reserved.

TM Therma is a Trademark of the Kingspan Group plc.

Kingspan Insulation Ltd is not associated with, and its products have not necessarily been tested by, the GREENGUARD Environmental Institute.

Registered in England & Wales, No. 01882722. Registered Office: Pembroke, Leominster, Herefordshire HR6 9LA UK. VAT GB428602456.

Registered in Ireland, No. 54621. Registered Office: Bree Industrial Estate, Castleblayney, Co. Monaghan, Ireland. VAT IE4575069I.

